

# 12A $\mu$ Module Regulators with PLL, Output Tracking and Margining

## FEATURES

- Complete Switch Mode Power Supply
- Wide Input Voltage Range: 4.5V to 20V
- 12A DC Typical, 14A Peak Output Current
- 0.6V to 5V Output Voltage
- Output Voltage Tracking and Margining
- Parallel Multiple  $\mu$ Module Regulators for Current Sharing
- Differential Remote Sensing for Precision Regulation (LTM4601 Only)
- PLL Frequency Synchronization
- $\pm 1.5\%$  Regulation
- Current Foldback Protection (Disabled at Start-Up)
- SnPb or RoHS Compliant Finish
- UltraFast™ Transient Response
- Current Mode Control
- Up to 95% Efficiency at 5V<sub>IN</sub>, 3.3V<sub>OUT</sub>
- Programmable Soft-Start
- Output Overvoltage Protection
- Small Footprint, Low Profile  
 (15mm × 15mm × 2.82mm) Surface Mount LGA and  
 (15mm × 15mm × 3.42mm) BGA Packages

## APPLICATIONS

- Telecom and Networking Equipment
- Servers
- Industrial Equipment
- Point of Load Regulation

## DESCRIPTION

The LTM<sup>®</sup>4601 is a complete 12A step-down switch mode DC/DC power supply with onboard switching controller, MOSFETs, inductor and all support components. The  $\mu$ Module<sup>®</sup> regulator is housed in small surface mount 15mm × 15mm × 2.82mm LGA and 15mm × 15mm × 3.42mm BGA packages. Operating over an input voltage range of 4.5V to 20V, the LTM4601 supports an output voltage range of 0.6V to 5V as well as output voltage tracking and margining. The high efficiency design delivers 12A continuous current (14A peak). Only bulk input and output capacitors are needed to complete the design.

The low profile and light weight package easily mounts in unused space on the back side of PC boards for high density point of load regulation. The  $\mu$ Module regulator can be synchronized with an external clock for reducing undesirable frequency harmonics and allows PolyPhase<sup>®</sup> operation for high load currents.

A high switching frequency and adaptive on-time current mode architecture deliver a very fast transient response to line and load changes without sacrificing stability. An onboard differential remote sense amplifier can be used to accurately regulate an output voltage independent of load current. The onboard remote sense amplifier is not available in the LTM4601-1.

LT, LT, LTC, LTM, Linear Technology, the Linear logo,  $\mu$ Module and PolyPhase are registered trademarks and UltraFast and LTpowerCAD are trademarks of Linear Technology Corporation. All other trademarks are the property of their respective owners. Protected by U.S. Patents including 5481178, 5847554, 6580258, 6304066, 6476589, 6774611, 6677210.

## TYPICAL APPLICATION

1.5V/12A Power Supply with 4.5V to 20V Input

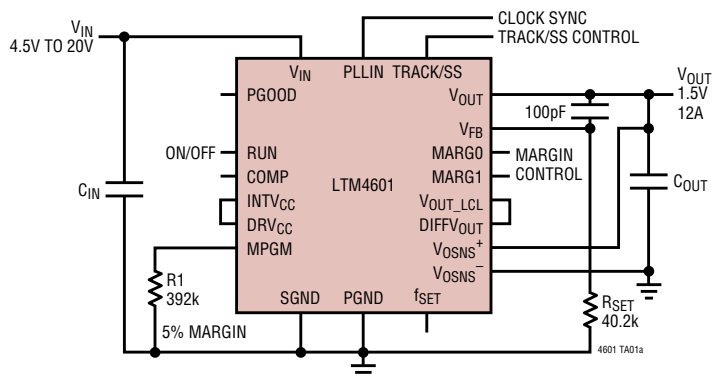

Efficiency and Power Loss vs Load Current

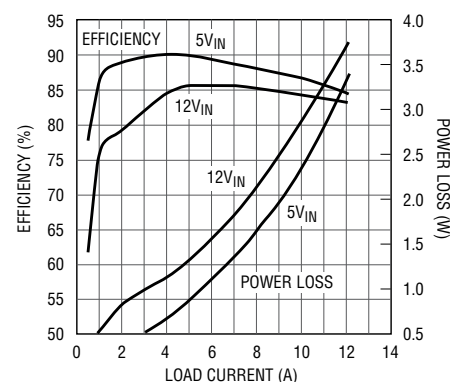

4601 TA01b

4601fe

# LTM4601

## ABSOLUTE MAXIMUM RATINGS

(Note 1)

INTV<sub>CC</sub>, DRV<sub>CC</sub>, V<sub>OUT\_LCL</sub>, V<sub>OUT</sub> (V<sub>OUT</sub> ≤ 3.3V with DIFFV<sub>OUT</sub>) ..... -0.3V to 6V  
 PLLIN, TRACK/SS, MPGM, MARG0, MARG1, PGOOD, f<sub>SET</sub> ..... -0.3V to INTV<sub>CC</sub> + 0.3V  
 RUN (Note 5) ..... -0.3V to 5V  
 V<sub>FB</sub>, COMP ..... -0.3V to 2.7V

V<sub>IN</sub> ..... -0.3V to 20V  
 V<sub>OSNS</sub><sup>+</sup>, V<sub>OSNS</sub><sup>-</sup> ..... -0.3V to INTV<sub>CC</sub> + 0.3V  
 Operating Temperature Range (Note 2).... -40°C to 85°C  
 Junction Temperature ..... 125°C  
 Storage Temperature Range ..... -55°C to 125°C  
 Reflow (Peak Body) Temperature..... 245°C

## PIN CONFIGURATION

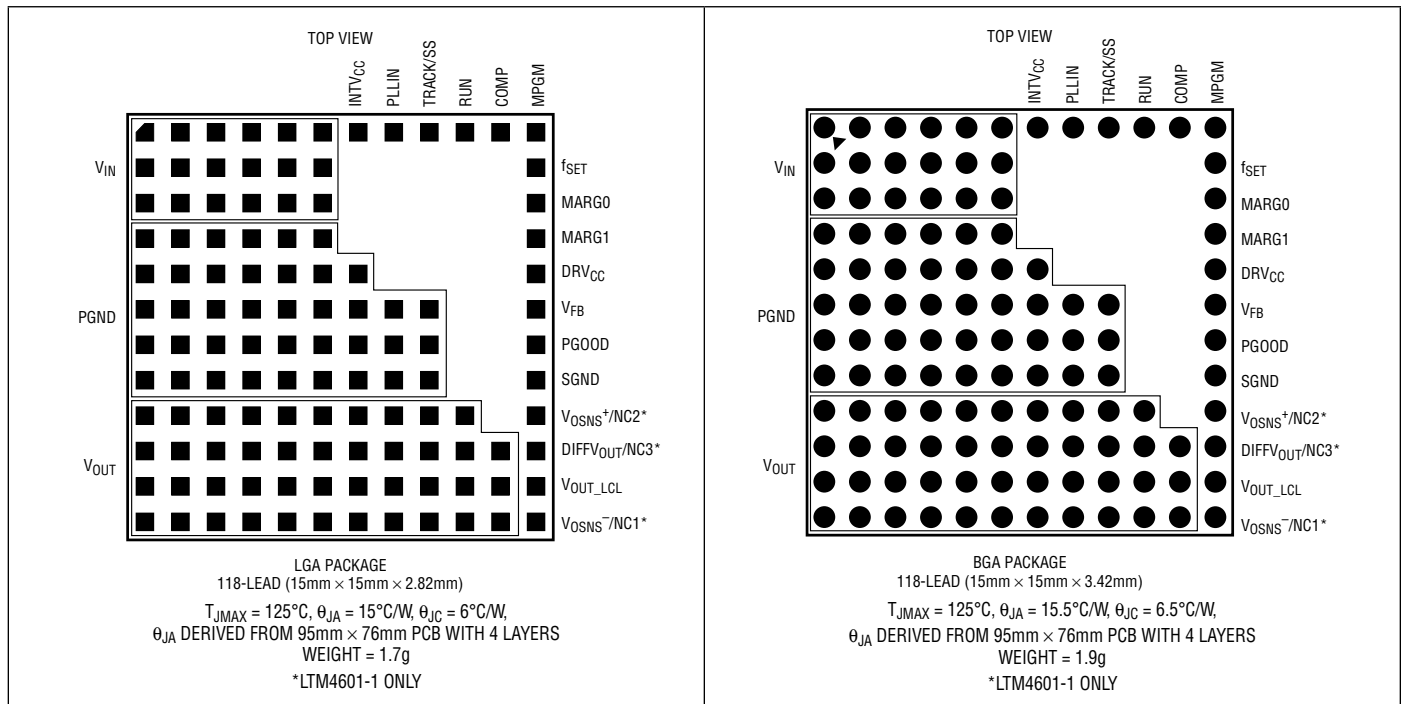

## ORDER INFORMATION

PART NUMBER	PAD OR BALL FINISH	PART MARKING*		PACKAGE TYPE	MSL RATING	TEMPERATURE RANGE (Note 2)
		DEVICE	FINISH CODE			
LTM4601EV#PBF	Au (RoHS)	LTM4601V	e4	LGA	3	-40°C to 85°C
LTM4601IV#PBF	Au (RoHS)	LTM4601V	e4	LGA	3	-40°C to 85°C
LTM4601EV-1#PBF	Au (RoHS)	LTM4601V-1	e4	LGA	3	-40°C to 85°C
LTM4601IV-1#PBF	Au (RoHS)	LTM4601V-1	e4	LGA	3	-40°C to 85°C
LTM4601EY#PBF	SAC305 (RoHS)	LTM4601Y	e1	BGA	3	-40°C to 85°C
LTM4601IY#PBF	SAC305 (RoHS)	LTM4601Y	e1	BGA	3	-40°C to 85°C
LTM4601EY-1#PBF	SAC305 (RoHS)	LTM4601Y-1	e1	BGA	3	-40°C to 85°C
LTM4601IY-1#PBF	SAC305 (RoHS)	LTM4601Y-1	e1	BGA	3	-40°C to 85°C
LTM4601IY	SnPb (63/37)	LTM4601Y	e0	BGA	3	-40°C to 85°C
LTM4601IY-1	SnPb (63/37)	LTM4601Y-1	e0	BGA	3	-40°C to 85°C

4601fe

## ORDER INFORMATION

Consult Marketing for parts specified with wider operating temperature ranges. \*Device temperature grade is indicated by a label on the shipping container. Pad or ball finish code is per IPC/JEDEC J-STD-609.

- Terminal Finish Part Marking:  
[www.linear.com/leadfree](http://www.linear.com/leadfree)

- Recommended LGA and BGA PCB Assembly and Manufacturing Procedures:  
[www.linear.com/umodule/pcbassembly](http://www.linear.com/umodule/pcbassembly)
- LGA and BGA Package and Tray Drawings:  
[www.linear.com/packaging](http://www.linear.com/packaging)

## ELECTRICAL CHARACTERISTICS

The ● denotes the specifications which apply over the  $-40^{\circ}\text{C}$  to  $85^{\circ}\text{C}$  temperature range (Note 2), otherwise specifications are at  $T_A = 25^{\circ}\text{C}$ ,  $V_{IN} = 12\text{V}$ , per typical application (front page) configuration.

SYMBOL	PARAMETER	CONDITIONS	MIN	TYP	MAX	UNITS	
$V_{IN(DC)}$	Input DC Voltage		●	4.5	20	V	
$V_{OUT(DC)}$	Output Voltage	$C_{IN} = 10\mu\text{F} \times 3$ , $C_{OUT} = 200\mu\text{F}$ , $R_{SET} = 40.2\text{k}$ $V_{IN} = 5\text{V}$ , $V_{OUT} = 1.5\text{V}$ , $I_{OUT} = 0\text{A}$ $V_{IN} = 12\text{V}$ , $V_{OUT} = 1.5\text{V}$ , $I_{OUT} = 0\text{A}$	● ●	1.478 1.478	1.5 1.5	1.522 1.522	V V

### Input Specifications

$V_{IN(UVLO)}$	Undervoltage Lockout Threshold	$I_{OUT} = 0\text{A}$		3.2	4	V	
$I_{INRUSH(VIN)}$	Input Inrush Current at Start-Up	$I_{OUT} = 0\text{A}$ , $V_{OUT} = 1.5\text{V}$ $V_{IN} = 5\text{V}$ $V_{IN} = 12\text{V}$		0.6 0.7		A A	
$I_{Q(VIN,NOLOAD)}$	Input Supply Bias Current	$V_{IN} = 12\text{V}$ , No Switching $V_{IN} = 12\text{V}$ , $V_{OUT} = 1.5\text{V}$ , Switching Continuous $V_{IN} = 5\text{V}$ , No Switching $V_{IN} = 5\text{V}$ , $V_{OUT} = 1.5\text{V}$ , Switching Continuous Shutdown, RUN = 0, $V_{IN} = 12\text{V}$		3.8 38 2.5 42 22		mA mA mA mA $\mu\text{A}$	
$I_S(VIN)$	Input Supply Current	$V_{IN} = 12\text{V}$ , $V_{OUT} = 1.5\text{V}$ , $I_{OUT} = 12\text{A}$ $V_{IN} = 12\text{V}$ , $V_{OUT} = 3.3\text{V}$ , $I_{OUT} = 12\text{A}$ $V_{IN} = 5\text{V}$ , $V_{OUT} = 1.5\text{V}$ , $I_{OUT} = 12\text{A}$		1.81 3.63 4.29		A A A	
$INTV_{CC}$	$V_{IN} = 12\text{V}$ , RUN > 2V	No Load		4.7	5	5.3	V

### Output Specifications

$I_{OUTDC}$	Output Continuous Current Range	$V_{IN} = 12\text{V}$ , $V_{OUT} = 1.5\text{V}$ (Note 6)		0	12	A
$\Delta V_{OUT(LINE)}$ $V_{OUT}$	Line Regulation Accuracy	$V_{OUT} = 1.5\text{V}$ , $I_{OUT} = 0\text{A}$ , $V_{IN}$ from 4.5V to 20V	●		0.3	%
$\Delta V_{OUT(LOAD)}$ $V_{OUT}$	Load Regulation Accuracy	$V_{OUT} = 1.5\text{V}$ , 0A to 12A (Note 6) $V_{IN} = 12\text{V}$ , with Remote Sense Amplifier $V_{IN} = 12\text{V}$ (LTM4601-1)	● ●		0.25 1	% %
$V_{OUT(AC)}$	Output Ripple Voltage	$I_{OUT} = 0\text{A}$ , $C_{OUT} = 2 \times 100\mu\text{F}$ X5R Ceramic $V_{IN} = 12\text{V}$ , $V_{OUT} = 1.5\text{V}$ $V_{IN} = 5\text{V}$ , $V_{OUT} = 1.5\text{V}$		20 18		mV <sub>p-p</sub> mV <sub>p-p</sub>
$f_s$	Output Ripple Voltage Frequency	$I_{OUT} = 5\text{A}$ , $V_{IN} = 12\text{V}$ , $V_{OUT} = 1.5\text{V}$		850		kHz
$\Delta V_{OUT(START)}$	Turn-On Overshoot	$C_{OUT} = 200\mu\text{F}$ , $V_{OUT} = 1.5\text{V}$ , $I_{OUT} = 0\text{A}$ , TRACK/SS = 10nF $V_{IN} = 12\text{V}$ $V_{IN} = 5\text{V}$		20 20		mV mV
$t_{START}$	Turn-On Time	$C_{OUT} = 200\mu\text{F}$ , $V_{OUT} = 1.5\text{V}$ , TRACK/SS = Open, $I_{OUT} = 1\text{A}$ Resistive Load $V_{IN} = 12\text{V}$ $V_{IN} = 5\text{V}$		0.5 0.5		ms ms

## ELECTRICAL CHARACTERISTICS

The ● denotes the specifications which apply over the  $-40^{\circ}\text{C}$  to  $85^{\circ}\text{C}$  temperature range (Note 2), otherwise specifications are at  $T_A = 25^{\circ}\text{C}$ ,  $V_{IN} = 12\text{V}$ , per typical application (front page) configuration.

SYMBOL	PARAMETER	CONDITIONS	MIN	TYP	MAX	UNITS
$\Delta V_{OUTLS}$	Peak Deviation for Dynamic Load	Load: 0% to 50% to 0% of Full Load, $C_{OUT} = 2 \times 22\mu\text{F}$ Ceramic, $470\mu\text{F}$ 4V Sanyo POSCAP $V_{IN} = 12\text{V}$ $V_{IN} = 5\text{V}$		35 35		mV mV
$t_{SETTLE}$	Settling Time for Dynamic Load Step	Load: 0% to 50%, or 50% to 0% of Full Load $V_{IN} = 12\text{V}$		25		$\mu\text{s}$
$I_{OUTPK}$	Output Current Limit	$C_{OUT} = 200\mu\text{F}$ Ceramic $V_{IN} = 12\text{V}$ , $V_{OUT} = 1.5\text{V}$ $V_{IN} = 5\text{V}$ , $V_{OUT} = 1.5\text{V}$		17 17		A A

### Remote Sense Amp (Note 3) (LTM4601 Only, Not Supported in the LTM4601-1)

$V_{OSNS^+}$ , $V_{OSNS^-}$ CM Range	Common Mode Input Voltage Range	$V_{IN} = 12\text{V}$ , $RUN > 2\text{V}$	0		$INTV_{CC} - 1$	V
$DIFV_{OUT}$ Range	Output Voltage Range	$V_{IN} = 12\text{V}$ , $DIFV_{OUT}$ Load = 100k	0		$INTV_{CC} - 1$	V
$V_{OS}$	Input Offset Voltage Magnitude				1.25	mV
$A_V$	Differential Gain			1		V/V
GBP	Gain Bandwidth Product			3		MHz
SR	Slew Rate			2		V/ $\mu\text{s}$
$R_{IN}$	Input Resistance	$V_{OSNS^+}$ to GND		20		$\text{k}\Omega$
CMRR	Common Mode Rejection Mode			100		dB

### Control Stage

$V_{FB}$	Error Amplifier Input Voltage Accuracy	$I_{OUT} = 0\text{A}$ , $V_{OUT} = 1.5\text{V}$	●	0.594	0.6	0.606	V
$V_{RUN}$	RUN Pin On/Off Threshold			1	1.5	1.9	V
$I_{TRACK/SS}$	Soft-Start Charging Current	$V_{TRACK/SS} = 0\text{V}$		-1.0	-1.5	-2.0	$\mu\text{A}$
$t_{ON(MIN)}$	Minimum On Time	(Note 4)			50	100	ns
$t_{OFF(MIN)}$	Minimum Off Time	(Note 4)			250	400	ns
$R_{PLLIN}$	PLLIN Input Resistance				50		$\text{k}\Omega$
$I_{DRVCC}$	Current into $DRV_{CC}$ Pin	$V_{OUT} = 1.5\text{V}$ , $I_{OUT} = 1\text{A}$ , $DRV_{CC} = 5\text{V}$			18	25	mA
$R_{FBHI}$	Resistor Between $V_{OUT\_LCL}$ and $V_{FB}$			60.098	60.4	60.702	$\text{k}\Omega$
$V_{MPPGM}$	Margin Reference Voltage				1.18		V
$V_{MARG0}$ , $V_{MARG1}$	MARG0, MARG1 Voltage Thresholds				1.4		V

### PGOOD Output

$\Delta V_{FBH}$	PGOOD Upper Threshold	$V_{FB}$ Rising		7	10	13	%
$\Delta V_{FBL}$	PGOOD Lower Threshold	$V_{FB}$ Falling		-7	-10	-13	%
$\Delta V_{FB(HYS)}$	PGOOD Hysteresis	$V_{FB}$ Returning			1.5		%

**Note 1:** Stresses beyond those listed under Absolute Maximum Ratings may cause permanent damage to the device. Exposure to any Absolute Maximum Rating condition for extended periods may affect device reliability and lifetime.

**Note 2:** The LTM4601 is tested under pulsed load conditions such that  $T_J \approx T_A$ . The LTM4601E/LTM4601E-1 are guaranteed to meet performance specifications from  $0^{\circ}\text{C}$  to  $85^{\circ}\text{C}$ . Specifications over the  $-40^{\circ}\text{C}$  to  $85^{\circ}\text{C}$  operating temperature range are assured by design, characterization and

correlation with statistical process controls. The LTM4601/LTM4601-1 are guaranteed over the  $-40^{\circ}\text{C}$  to  $85^{\circ}\text{C}$  operating temperature range.

**Note 3:** Remote sense amplifier recommended for  $\leq 3.3\text{V}$  output.

**Note 4:** 100% tested at wafer level only.

**Note 5:** Limit current into RUN pin to less than 1mA.

**Note 6:** See output current derating curves for different  $V_{IN}$ ,  $V_{OUT}$  and  $T_A$ .

**TYPICAL PERFORMANCE CHARACTERISTICS** (See Figure 18 for all curves)

**Efficiency vs Load Current with 5V<sub>IN</sub>**

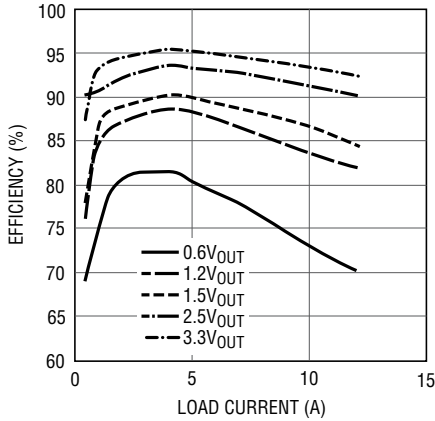

4601 G01

**Efficiency vs Load Current with 12V<sub>IN</sub>**

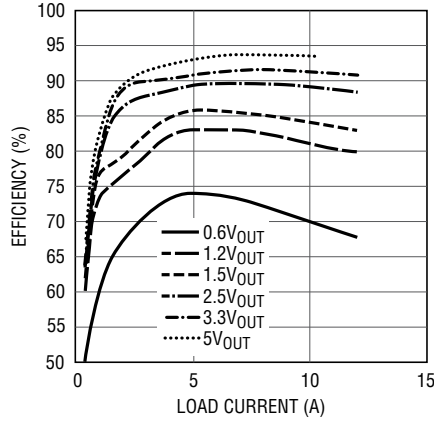

4601 G02

**Efficiency vs Load Current with 20V<sub>IN</sub>**

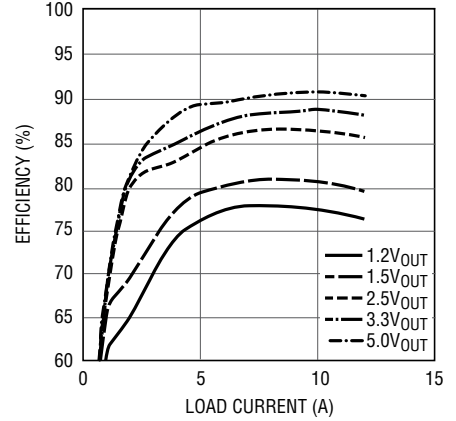

4601 G03

**1.2V Transient Response**

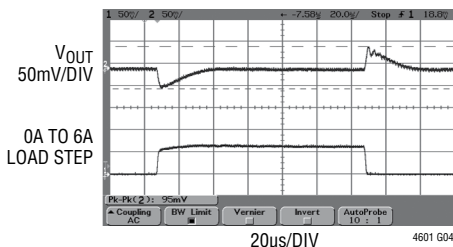

4601 G04

1.2V AT 6A/µs LOAD STEP  
C<sub>OUT</sub> = 3 • 22µF 6.3V CERAMICS  
470µF 4V SANYO POSCAP  
C3 = 100pF

**1.5V Transient Response**

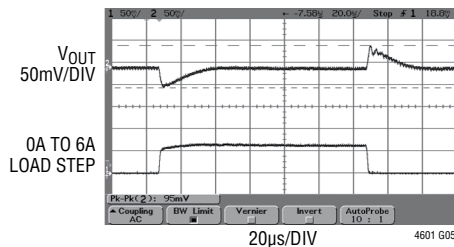

4601 G05

1.5V AT 6A/µs LOAD STEP  
C<sub>OUT</sub> = 3 • 22µF 6.3V CERAMICS  
470µF 4V SANYO POSCAP  
C3 = 100pF

**1.8V Transient Response**

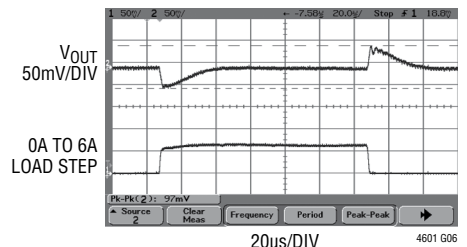

4601 G06

1.8V AT 6A/µs LOAD STEP  
C<sub>OUT</sub> = 3 • 22µF 6.3V CERAMICS  
470µF 4V SANYO POSCAP  
C3 = 100pF

**2.5V Transient Response**

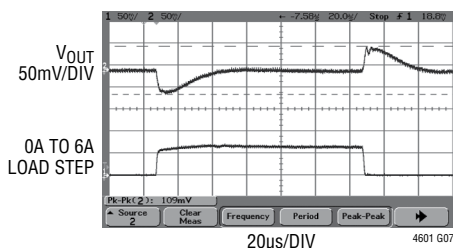

4601 G07

2.5V AT 6A/µs LOAD STEP  
C<sub>OUT</sub> = 3 • 22µF 6.3V CERAMICS  
470µF 4V SANYO POSCAP  
C3 = 100pF

**3.3V Transient Response**

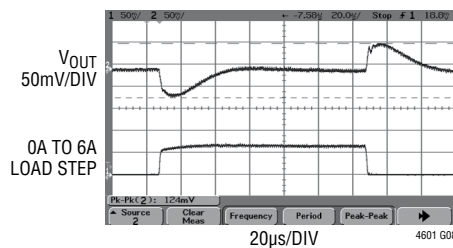

4601 G08

3.3V AT 6A/µs LOAD STEP  
C<sub>OUT</sub> = 3 • 22µF 6.3V CERAMICS  
470µF 4V SANYO POSCAP  
C3 = 100pF

## TYPICAL PERFORMANCE CHARACTERISTICS (See Figure 18 for all curves)

**Start-Up,  $I_{OUT} = 0A$**

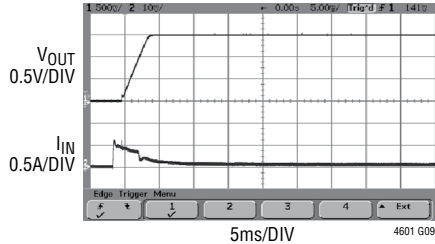

$V_{IN} = 12V$   
 $V_{OUT} = 1.5V$   
 $C_{OUT} = 470\mu F, 3 \times 22\mu F$   
 SOFT-START = 10nF

**Start-Up,  $I_{OUT} = 12A$   
 (Resistive Load)**

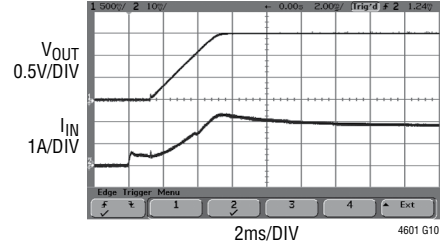

$V_{IN} = 12V$   
 $V_{OUT} = 1.5V$   
 $C_{OUT} = 470\mu F, 3 \times 22\mu F$   
 SOFT-START = 10nF

**$V_{IN}$  to  $V_{OUT}$  Step-Down Ratio**

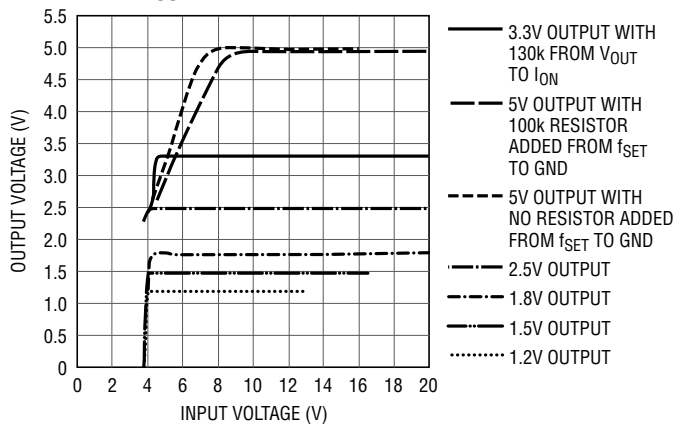

4601 G11

**Track,  $I_{OUT} = 12A$**

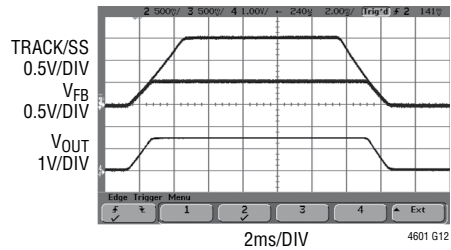

$V_{IN} = 12V$   
 $V_{OUT} = 1.5V$   
 $C_{OUT} = 470\mu F, 3 \times 22\mu F$   
 SOFT-START = 10nF

**Short-Circuit Protection,  $I_{OUT} = 0A$**

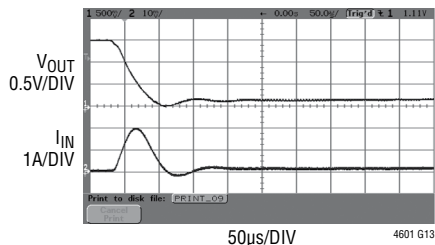

$V_{IN} = 12V$   
 $V_{OUT} = 1.5V$   
 $C_{OUT} = 470\mu F, 3 \times 22\mu F$   
 SOFT-START = 10nF

**Short-Circuit Protection,  $I_{OUT} = 12A$**

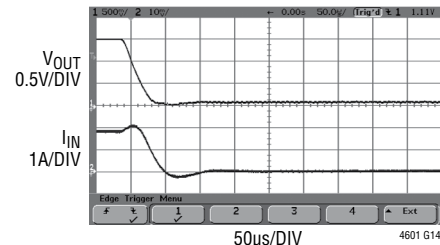

$V_{IN} = 12V$   
 $V_{OUT} = 1.5V$   
 $C_{OUT} = 470\mu F, 3 \times 22\mu F$   
 SOFT-START = 10nF

## PIN FUNCTIONS (See Package Description for Pin Assignment)

**V<sub>IN</sub> (Bank 1):** Power Input Pins. Apply input voltage between these pins and PGND pins. Recommend placing input decoupling capacitance directly between V<sub>IN</sub> pins and PGND pins.

**V<sub>OUT</sub> (Bank 3):** Power Output Pins. Apply output load between these pins and PGND pins. Recommend placing output decoupling capacitance directly between these pins and PGND pins. See Figure 15.

**PGND (Bank 2):** Power ground pins for both input and output returns.

**V<sub>OSNS</sub><sup>-</sup> (Pin M12):** (-) Input to the Remote Sense Amplifier. This pin connects to the ground remote sense point. The remote sense amplifier is used for V<sub>OUT</sub> ≤ 3.3V. Tie to INTV<sub>CC</sub> if not used.

**NC1 (Pin M12):** No internal connection on the LTM4601-1.

**V<sub>OSNS</sub><sup>+</sup> (Pin J12):** (+) Input to the Remote Sense Amplifier. This pin connects to the output remote sense point. The remote sense amplifier is used for V<sub>OUT</sub> ≤ 3.3V. Tie to ground if not used.

**NC2 (Pin J12):** No internal connection on the LTM4601-1.

**DIFFV<sub>OUT</sub> (Pin K12):** Output of the Remote Sense Amplifier. This pin connects to the V<sub>OUT\_LCL</sub> pin. Leave floating if not used.

**NC3 (Pin K12):** No internal connection on the LTM4601-1.

**DRV<sub>CC</sub> (Pin E12):** This pin normally connects to INTV<sub>CC</sub> for powering the internal MOSFET drivers. This pin can be biased up to 6V from an external supply with about 50mA capability, or an external circuit as shown in Figure 16. This improves efficiency at the higher input voltages by reducing power dissipation in the module.

**INTV<sub>CC</sub> (Pin A7):** This pin is for additional decoupling of the 5V internal regulator.

**PLLIN (Pin A8):** External Clock Synchronization Input to the Phase Detector. This pin is internally terminated to SGND with a 50k resistor. Apply a clock with a high level above 2V and below INTV<sub>CC</sub>. See the Applications Information section.

**TRACK/SS (Pin A9):** Output Voltage Tracking and Soft-Start Pin. When the module is configured as a master output, then a soft-start capacitor is placed from this pin to ground to control the master ramp rate. A soft-start capacitor can also be used for soft-start turn-on of a stand alone regulator. Slave operation is performed by putting a resistor divider from the master output to the ground, and connecting the center point of the divider to this pin. See the Applications Information section.

**MPGM (Pin A12):** Programmable Margining Input. A resistor from this pin to ground sets a current that is equal to 1.18V/R. This current multiplied by 10kΩ will equal a value in millivolts that is a percentage of the 0.6V reference voltage. See the Applications Information section. To parallel LTM4601s, each requires an individual MPGM resistor. Do not tie MPGM pins together.

**f<sub>SET</sub> (Pin B12):** Frequency Set Internally to 850kHz. An external resistor can be placed from this pin to ground to increase frequency. See the Applications Information section for frequency adjustment.

**V<sub>FB</sub> (Pin F12):** The Negative Input of the Error Amplifier. Internally, this pin is connected to V<sub>OUT\_LCL</sub> pin with a 60.4k precision resistor. Different output voltages can be programmed with an additional resistor between V<sub>FB</sub> and SGND pins. See the Applications Information section.

**MARG0 (Pin C12):** This pin is the LSB logic input for the margining function. Together with the MARG1 pin it will determine if margin high, margin low or no margin state is applied. The pin has an internal pull-down resistor of 50k. See the Applications Information section.

**MARG1 (Pin D12):** This pin is the MSB logic input for the margining function. Together with the MARG0 pin it will determine if margin high, margin low or no margin state is applied. The pin has an internal pull-down resistor of 50k. See the Applications Information section.



## **PIN FUNCTIONS** (See Package Description for Pin Assignment)

**SGND (Pin H12):** Signal Ground. This pin connects to PGND at output capacitor point. See Figure 15.

**COMP (Pin A11):** Current Control Threshold and Error Amplifier Compensation Point. The current comparator threshold increases with this control voltage. The voltage ranges from 0V to 2.4V with 0.7V corresponding to zero sense voltage (zero current).

**PGOOD (Pin G12):** Output Voltage Power Good Indicator. Open-drain logic output that is pulled to ground when the output voltage is not within  $\pm 10\%$  of the regulation point, after a 25 $\mu$ s power bad mask timer expires.

**RUN (Pin A10):** Run Control Pin. A voltage above 1.9V will turn on the module, and when below 1V, will turn off the module. A programmable UVLO function can be accomplished by connecting to a resistor divider from  $V_{IN}$  to ground. See Figure 1. This pin has a 5.1V Zener to ground. Maximum pin voltage is 5V. Limit current into the RUN pin to less than 1mA.

**$V_{OUT\_LCL}$  (Pin L12):**  $V_{OUT}$  connects directly to this pin to bypass the remote sense amplifier, or  $DIFV_{OUT}$  connects to this pin when the remote sense amplifier is used.  $V_{OUT\_LCL}$  can be connected to  $V_{OUT}$  on the LTM4601-1,  $V_{OUT}$  is internally connected to  $V_{OUT\_LCL}$  with 50 $\Omega$  in the LTM4601-1.



# SIMPLIFIED BLOCK DIAGRAM

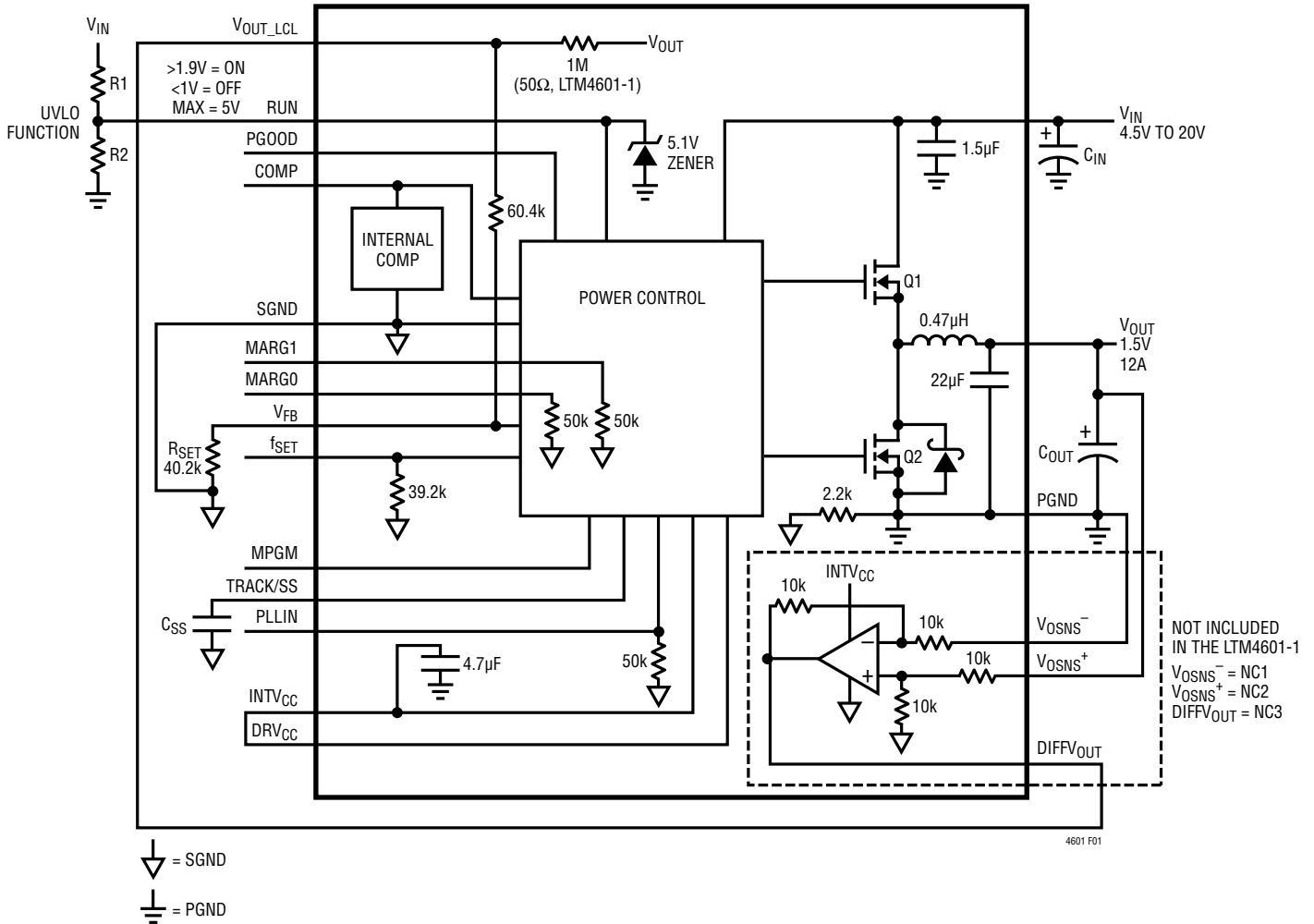

Figure 1. Simplified LTM4601/LTM4601-1 Block Diagram

## DECOUPLING REQUIREMENTS $T_A = 25^\circ\text{C}$ , $V_{IN} = 12\text{V}$ . Use Figure 1 configuration.

SYMBOL	PARAMETER	CONDITIONS	MIN	TYP	MAX	UNITS
$C_{IN}$	External Input Capacitor Requirement ( $V_{IN} = 4.5\text{V to }20\text{V}$ , $V_{OUT} = 1.5\text{V}$ )	$I_{OUT} = 12\text{A}$ , $3 \times 10\mu\text{F Ceramics}$	20	30		$\mu\text{F}$
$C_{OUT}$	External Output Capacitor Requirement ( $V_{IN} = 4.5\text{V to }20\text{V}$ , $V_{OUT} = 1.5\text{V}$ )	$I_{OUT} = 12\text{A}$	100	200		$\mu\text{F}$

## OPERATION

### Power Module Description

The LTM4601 is a standalone nonisolated switching mode DC/DC power supply. It can deliver up to 12A of DC output current with some external input and output capacitors. This module provides a precisely regulated output voltage programmable via one external resistor from  $0.6V_{DC}$  to  $5.0V_{DC}$  over a 4.5V to 20V wide input voltage. The typical application schematic is shown in Figure 18.

The LTM4601 has an integrated constant on-time current mode regulator, ultralow  $R_{DS(ON)}$  FETs with fast switching speed and integrated Schottky diodes. The typical switching frequency is 850kHz at full load. With current mode control and internal feedback loop compensation, the LTM4601 module has sufficient stability margins and good transient performance under a wide range of operating conditions and with a wide range of output capacitors, even all ceramic output capacitors.

Current mode control provides cycle-by-cycle fast current limit. Besides, foldback current limiting is provided in an overcurrent condition while  $V_{FB}$  drops. Internal overvoltage and undervoltage comparators pull the open-drain PGOOD output low if the output feedback voltage exits a  $\pm 10\%$  window around the regulation point. Furthermore, in an overvoltage condition, internal top FET Q1 is turned off and bottom FET Q2 is turned on and held on until the overvoltage condition clears.

Pulling the RUN pin below 1V forces the controller into its shutdown state, turning off both Q1 and Q2. At low load current, the module works in continuous current mode by default to achieve minimum output ripple voltage.

When  $DRV_{CC}$  pin is connected to  $INTV_{CC}$  an integrated 5V linear regulator powers the internal gate drivers. If a 5V external bias supply is applied on the  $DRV_{CC}$  pin, then an efficiency improvement will occur due to the reduced power loss in the internal linear regulator. This is especially true at the high end of the input voltage range.

The LTM4601 has a very accurate differential remote sense amplifier with very low offset. This provides for very accurate output voltage sensing at the load. The MPGM pin, MARG0 pin and MARG1 pin are used to support voltage margining, where the percentage of margin is programmed by the MPGM pin, and the MARG0 and MARG1 select margining.

The PLLIN pin provides frequency synchronization of the device to an external clock. The TRACK/SS pin is used for power supply tracking and soft-start programming.

## APPLICATIONS INFORMATION

The typical LTM4601 application circuit is shown in Figure 18. External component selection is primarily determined by the maximum load current and output voltage. Refer to Table 2 for specific external capacitor requirements for a particular application.

### $V_{IN}$ to $V_{OUT}$ Step-Down Ratios

There are restrictions in the maximum  $V_{IN}$  to  $V_{OUT}$  step down ratio that can be achieved for a given input voltage. These constraints are shown in the Typical Performance Characteristics curves labeled  $V_{IN}$  to  $V_{OUT}$  Step-Down Ratio. Note that additional thermal derating may apply. See the Thermal Considerations and Output Current Derating section of this data sheet.

### Output Voltage Programming and Margining

The PWM controller has an internal 0.6V reference voltage. As shown in the Block Diagram, a 1M and a 60.4k 0.5% internal feedback resistor connects  $V_{OUT}$  and  $V_{FB}$  pins together. The  $V_{OUT\_LCL}$  pin is connected between the 1M and the 60.4k resistor. The 1M resistor is used to protect against an output overvoltage condition if the  $V_{OUT\_LCL}$  pin is not connected to the output, or if the remote sense amplifier output is not connected to  $V_{OUT\_LCL}$ . In these cases, the output voltage will default to 0.6V. Adding a resistor  $R_{SET}$  from the  $V_{FB}$  pin to SGND pin programs the output voltage:

$$V_{OUT} = 0.6V \cdot \frac{60.4k + R_{SET}}{R_{SET}}$$

**Table 1.  $R_{SET}$  Standard 1% Resistor Values vs  $V_{OUT}$**

$R_{SET}$ (k $\Omega$ )	Open	60.4	40.2	30.1	25.5	19.1	13.3	8.25
$V_{OUT}$ (V)	0.6	1.2	1.5	1.8	2	2.5	3.3	5

The MPGM pin programs a current that when multiplied by an internal 10k resistor sets up the 0.6V reference  $\pm$  offset for margining. A 1.18V reference divided by the R<sub>PGM</sub> resistor on the MPGM pin programs the current. Calculate  $V_{OUT(MARGIN)}$ :

$$V_{OUT(MARGIN)} = \frac{\%V_{OUT}}{100} \cdot V_{OUT}$$

where  $\%V_{OUT}$  is the percentage of  $V_{OUT}$  you want to margin, and  $V_{OUT(MARGIN)}$  is the margin quantity in volts:

$$R_{PGM} = \frac{V_{OUT}}{0.6V} \cdot \frac{1.18V}{V_{OUT(MARGIN)}} \cdot 10k$$

where  $R_{PGM}$  is the resistor value to place on the MPGM pin to ground.

The margining voltage,  $V_{OUT(MARGIN)}$ , will be added or subtracted from the nominal output voltage as determined by the state of the MARG0 and MARG1 pins. See the truth table below:

MARG1	MARG0	MODE
LOW	LOW	NO MARGIN
LOW	HIGH	MARGIN UP
HIGH	LOW	MARGIN DOWN
HIGH	HIGH	NO MARGIN

### Input Capacitors

LTM4601 module should be connected to a low AC impedance DC source. Input capacitors are required to be placed adjacent to the module. In Figure 18, the 10 $\mu$ F ceramic input capacitors are selected for their ability to handle the large RMS current into the converter. An input bulk capacitor of 100 $\mu$ F is optional. This 100 $\mu$ F capacitor is only needed if the input source impedance is compromised by long inductive leads or traces.

## APPLICATIONS INFORMATION

For a buck converter, the switching duty-cycle can be estimated as:

$$D = \frac{V_{OUT}}{V_{IN}}$$

Without considering the inductor ripple current, the RMS current of the input capacitor can be estimated as:

$$I_{CIN(RMS)} = \frac{I_{OUT(MAX)}}{\eta\%} \cdot \sqrt{D \cdot (1-D)}$$

In the above equation,  $\eta\%$  is the estimated efficiency of the power module.  $C_{IN}$  can be a switcher-rated electrolytic aluminum capacitor, OS-CON capacitor or high value ceramic capacitor. Note the capacitor ripple current ratings are often based on temperature and hours of life. This makes it advisable to properly derate the input capacitor, or choose a capacitor rated at a higher temperature than required. Always contact the capacitor manufacturer for derating requirements.

In Figure 18, the  $10\mu\text{F}$  ceramic capacitors are together used as a high frequency input decoupling capacitor. In a typical 12A output application, three very low ESR, X5R or X7R,  $10\mu\text{F}$  ceramic capacitors are recommended. These decoupling capacitors should be placed directly adjacent to the module input pins in the PCB layout to minimize the trace inductance and high frequency AC noise. Each  $10\mu\text{F}$  ceramic is typically good for 2A to 3A of RMS ripple current. Refer to your ceramics capacitor catalog for the RMS current ratings.

Multiphase operation with multiple LTM4601 devices in parallel will lower the effective input RMS ripple current due to the interleaving operation of the regulators. Application Note 77 provides a detailed explanation. Refer to Figure 2 for the input capacitor ripple current reduction as a function of the number of phases. The figure provides a ratio of RMS ripple current to DC load current as function of duty cycle and the number of paralleled phases.

Pick the corresponding duty cycle and the number of phases to arrive at the correct ripple current value. For example, the 2-phase parallel LTM4601 design provides 24A at 2.5V output from a 12V input. The duty cycle is  $DC = 2.5\text{V}/12\text{V} = 0.21$ . The 2-phase curve has a ratio of  $\sim 0.25$  for a duty cycle of 0.21. This 0.25 ratio of RMS ripple current to a DC load current of 24A equals  $\sim 6\text{A}$  of input RMS ripple current for the external input capacitors.

### Output Capacitors

The LTM4601 is designed for low output ripple voltage. The bulk output capacitors defined as  $C_{OUT}$  are chosen with low enough effective series resistance (ESR) to meet the output voltage ripple and transient requirements.  $C_{OUT}$  can be a low ESR tantalum capacitor, a low ESR polymer capacitor or a ceramic capacitor. The typical capacitance is  $200\mu\text{F}$  if all ceramic output capacitors are used. Additional output filtering may be required by the system designer if further reduction of output ripple or dynamic transient spikes is required. Table 2 shows a matrix of different output voltages and output capacitors to minimize the voltage droop and overshoot during a  $5\text{A}/\mu\text{s}$  transient. The table optimizes total equivalent ESR and total bulk capacitance to maximize transient performance.

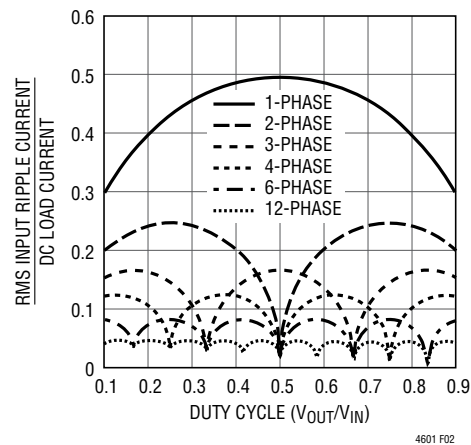

Figure 2. Normalized Input RMS Ripple Current vs Duty Cycle for One to Six Modules (Phases)

## APPLICATIONS INFORMATION

Multiphase operation with multiple LTM4601 devices in parallel will lower the effective output ripple current due to the interleaving operation of the regulators. For example, each LTM4601's inductor current in a 12V to 2.5V multiphase design can be read from the Inductor Ripple Current vs Duty Cycle graph (Figure 3). The large ripple current

at low duty cycle and high output voltage can be reduced by adding an external resistor from  $f_{SET}$  to ground which increases the frequency. If the duty cycle is  $DC = 2.5V/12V = 0.21$ , the inductor ripple current for 2.5V output at 21% duty cycle is ~6A in Figure 3.

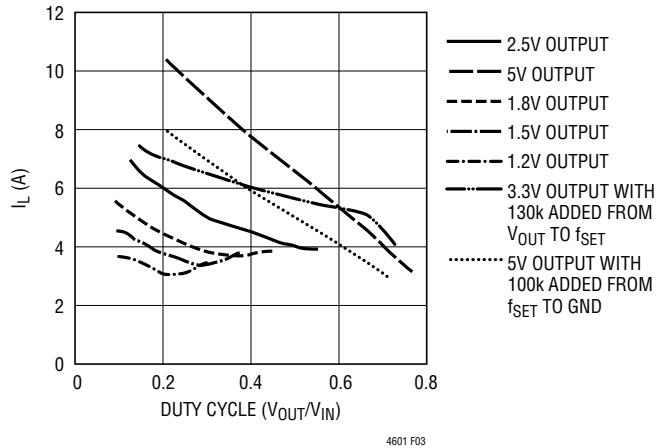

Figure 3. Inductor Ripple Current vs Duty Cycle

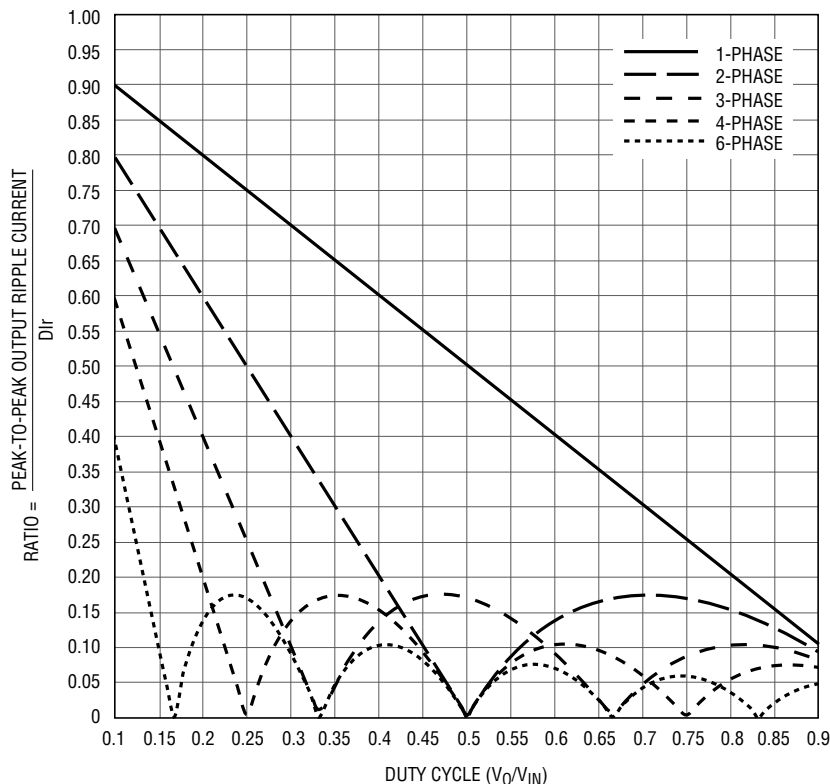

Figure 4. Normalized Output Ripple Current vs Duty Cycle,  $D_{Ir} = V_O T/L_I$ ,  $D_{Ir}$  = Each Phase's Inductor Current

## APPLICATIONS INFORMATION

Therefore, the output ripple voltage can be calculated with the known effective output ripple current. The equation:  $\Delta V_{OUT(P-P)} \approx (\Delta I_L / (8 \cdot f \cdot m \cdot C_{OUT}) + ESR \cdot \Delta I_L)$ , where  $f$  is frequency and  $m$  is the number of parallel phases. This calculation process can be easily accomplished by using LTpowerCAD™.

### Fault Conditions: Current Limit and Overcurrent Foldback

LTM4601 has a current mode controller, which inherently limits the cycle-by-cycle inductor current not only in steady-state operation, but also in response to transients.

To further limit current in the event of an overload condition, the LTM4601 provides foldback current limiting. If the output voltage falls by more than 50%, then the maximum output current is progressively lowered to about one sixth of its full current limit value.

### Soft-Start and Tracking

The TRACK/SS pin provides a means to either soft-start the regulator or track it to a different power supply. A capacitor on this pin will program the ramp rate of the output voltage. A 1.5µA current source will charge up the external soft-start capacitor to 80% of the 0.6V internal voltage reference plus or minus any margin delta. This will control the ramp of the internal reference and the output voltage. The total soft-start time can be calculated as:

$$t_{SOFTSTART} = 0.8 \cdot (0.6V \pm V_{OUT(MARGIN)}) \cdot \frac{C_{SS}}{1.5\mu A}$$

When the RUN pin falls below 1.5V, then the TRACK/SS pin is reset to allow for proper soft-start control when the regulator is enabled again. Current foldback and forced continuous mode are disabled during the soft-start process. The soft-start function can also be used to control the output ramp up time, so that another regulator can be easily tracked to it.

### Output Voltage Tracking

Output voltage tracking can be programmed externally using the TRACK/SS pin. The output can be tracked up and down with another regulator. The master regulator's output is divided down with an external resistor divider that is the same as the slave regulator's feedback divider. Figure 5 shows an example of coincident tracking. Ratiometric modes of tracking can be achieved by selecting different resistor values to change the output tracking ratio. The master output must be greater than the slave output for the tracking to work. Figure 6 shows the coincident output tracking characteristics.

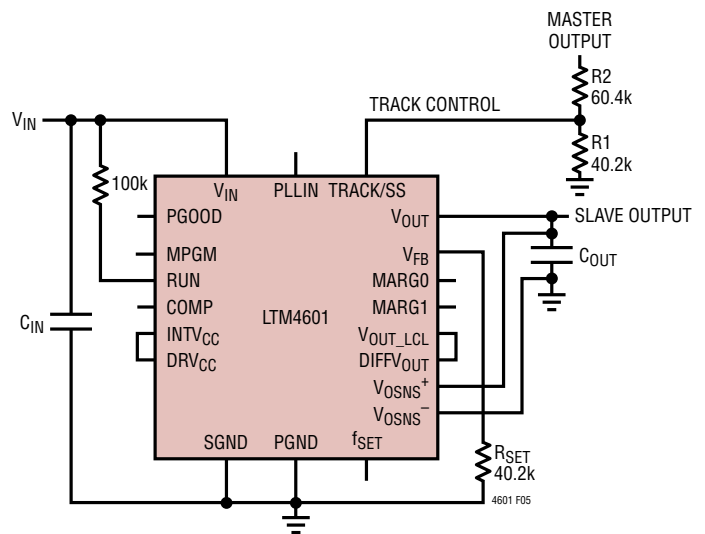

Figure 5. Coincident Tracking Schematic

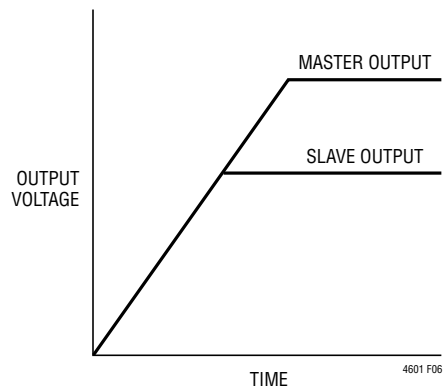

Figure 6. Coincident Output Tracking Characteristics

## APPLICATIONS INFORMATION

### Run Enable

The RUN pin is used to enable the power module. The pin has an internal 5.1V Zener to ground. The pin can be driven with a logic input not to exceed 5V.

The RUN pin can also be used as an undervoltage lock out (UVLO) function by connecting a resistor divider from the input supply to the RUN pin:

$$V_{UVLO} = \frac{R1+R2}{R2} \cdot 1.5V$$

See Figure 1, Simplified Block Diagram.

### Power Good

The PGOOD pin is an open-drain pin that can be used to monitor valid output voltage regulation. This pin monitors a  $\pm 10\%$  window around the regulation point and tracks with margining.

### COMP Pin

This pin is the external compensation pin. The module has already been internally compensated for most output voltages. Table 2 is provided for most application requirements. LTpowerCAD is available for other control loop optimization.

### PLLIN

The power module has a phase-locked loop comprised of an internal voltage controlled oscillator and a phase detector. This allows the internal top MOSFET turn-on to be locked to the rising edge of an external clock. The frequency range is  $\pm 30\%$  around the operating frequency of 850kHz. A pulse detection circuit is used to detect a clock on the PLLIN pin to turn on the phase-locked loop. The pulse width of the clock has to be at least 400ns and at least 2V in amplitude. The PLLIN pin must be driven from a low impedance source such as a logic gate located close to the pin. During the start-up of the regulator, the phase-locked loop function is disabled.

### INTV<sub>CC</sub> and DRV<sub>CC</sub> Connection

An internal low dropout regulator produces an internal 5V supply that powers the control circuitry and DRV<sub>CC</sub> for driving the internal power MOSFETs. Therefore, if the system does not have a 5V power rail, the LTM4601 can be directly powered by V<sub>IN</sub>. The gate driver current through the LDO is about 20mA. The internal LDO power dissipation can be calculated as:

$$P_{LDO\_LOSS} = 20mA \cdot (V_{IN} - 5V)$$

The LTM4601 also provides the external gate driver voltage pin DRV<sub>CC</sub>. If there is a 5V rail in the system, it is recommended to connect DRV<sub>CC</sub> pin to the external 5V rail. This is especially true for higher input voltages. Do not apply more than 6V to the DRV<sub>CC</sub> pin. A 5V output can be used to power the DRV<sub>CC</sub> pin with an external circuit as shown in Figure 16.

### Parallel Operation of the Module

The LTM4601 device is an inherently current mode controlled device. Parallel modules will have very good current sharing. This will balance the thermals on the design. The voltage feedback equation changes with the variable N as modules are paralleled:

$$V_{OUT} = 0.6V \frac{\frac{60.4k}{N} + R_{SET}}{R_{SET}}$$

N is the number of paralleled modules.

Figure 19 shows an LTM4601 and an LTM4601-1 used in a parallel design. The 2nd LTM4601 device does not require the remote sense amplifier, therefore, the LTM4601-1 device is used. An LTM4601 device can be used without the diff amp. V<sub>OSNS</sub><sup>+</sup> can be tied to ground and the V<sub>OSNS</sub><sup>-</sup> can be tied to INTV<sub>CC</sub>. DIFFV<sub>OUT</sub> can float. When using multiple LTM4601-1 devices in parallel with an LTM4601, limit the number to five for a total of six modules in parallel.



## APPLICATIONS INFORMATION

### Thermal Considerations and Output Current Derating

The power loss curves in Figures 7 and 8 can be used in coordination with the load current derating curves in Figures 9 to 14 for calculating an approximate  $\theta_{JA}$  for the module with various heat sinking methods. Thermal models are derived from several temperature measurements at the bench and thermal modeling analysis. Thermal Application Note 103 provides a detailed explanation of the analysis for the thermal models and the derating curves. Tables 3 and 4 provide a summary of the equivalent  $\theta_{JA}$  for the noted conditions. These equivalent  $\theta_{JA}$  parameters are correlated to the measured values, and are improved with air flow. The case temperature is maintained at 100°C

or below for the derating curves. The maximum case temperature of 100°C is to allow for a rise of about 13°C to 25°C inside the  $\mu$ Module with a thermal resistance  $\theta_{JC}$  from junction to case between 6°C/W to 9°C/W. This will maintain the maximum junction temperature inside the  $\mu$ Module regulator below 125°C.

### Safety Considerations

The LTM4601 modules do not provide isolation from  $V_{IN}$  to  $V_{OUT}$ . There is no internal fuse. If required, a slow blow fuse with a rating twice the maximum input current needs to be provided to protect each unit from catastrophic failure.

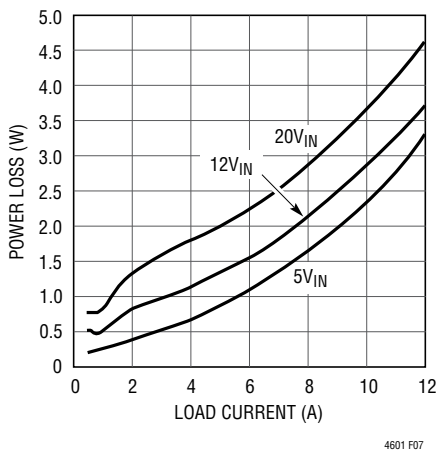

Figure 7. 1.5V Power Loss

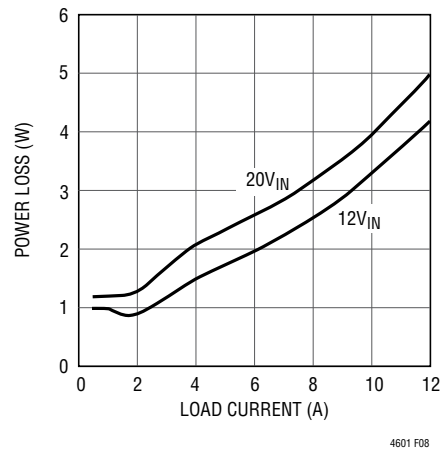

Figure 8. 3.3V Power Loss

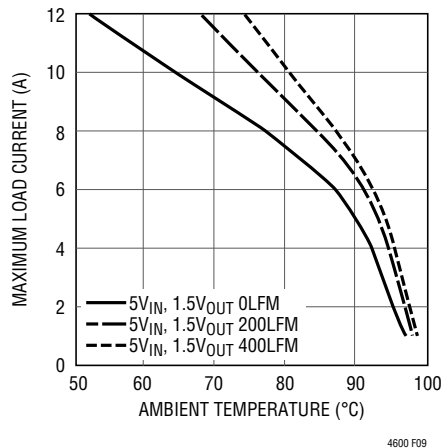

Figure 9. No Heat Sink 5V<sub>IN</sub>

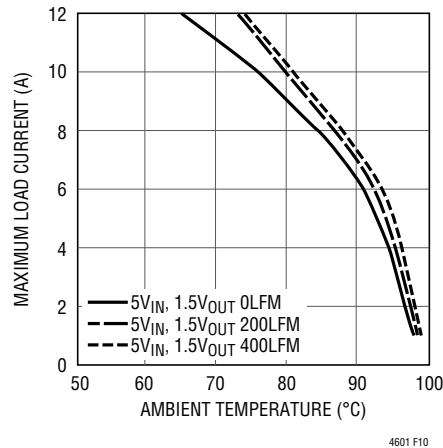

Figure 10. BGA Heat Sink 5V<sub>IN</sub>

# APPLICATIONS INFORMATION

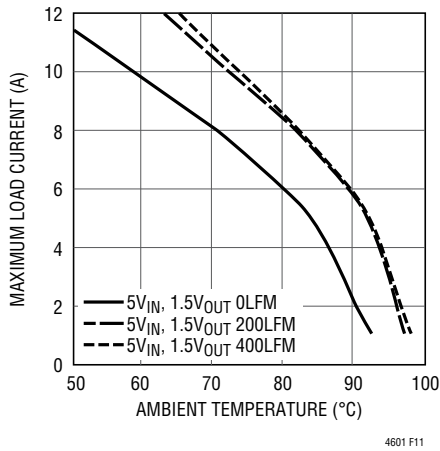

Figure 11. No Heat Sink 12V<sub>IN</sub>

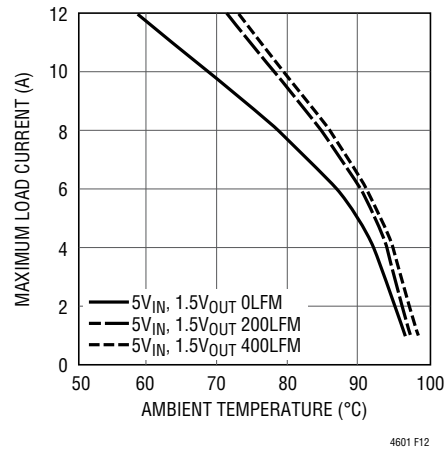

Figure 12. BGA Heat Sink 12V<sub>IN</sub>

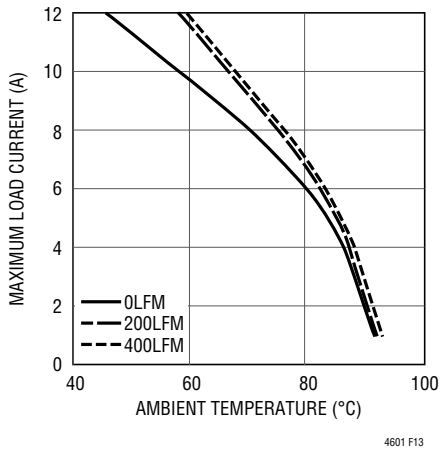

Figure 13. 12V<sub>IN</sub>, 3.3V<sub>OUT</sub>, No Heat Sink

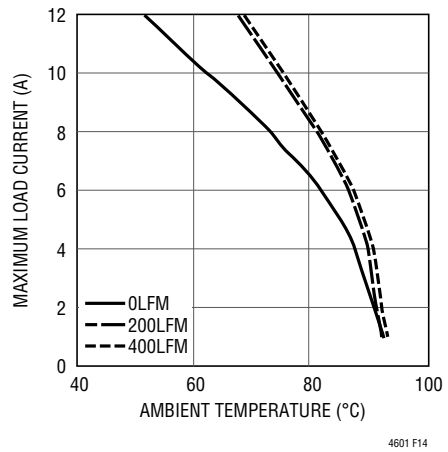

Figure 14. 12V<sub>IN</sub>, 3.3V<sub>OUT</sub>, BGA Heat Sink

## APPLICATIONS INFORMATION

**Table 2. Output Voltage Response Versus Component Matrix (Refer to Figure 18), 0A to 6A Load Step**
**TYPICAL MEASURED VALUES**

<b>C<sub>OUT1</sub> VENDORS</b>	<b>PART NUMBER</b>	<b>C<sub>OUT2</sub> VENDORS</b>	<b>PART NUMBER</b>
TDK	C4532X5R0J107MZ (100μF, 6.3V)	SANYO POS CAP	6TPE330MIL (330μF, 6.3V)
TAIYO YUDEN	JMK432BJ107MU-T (100μF, 6.3V)	SANYO POS CAP	2R5TPE470M9 (470μF, 2.5V)
TAIYO YUDEN	JMK316BJ226ML-T501 (22μF, 6.3V)	SANYO POS CAP	4TPE470MCL (470μF, 4V)

<b>V<sub>OUT</sub> (V)</b>	<b>C<sub>IN</sub> (CERAMIC)</b>	<b>C<sub>IN</sub> (BULK)</b>	<b>C<sub>OUT1</sub> (CERAMIC)</b>	<b>C<sub>OUT2</sub> (BULK)</b>	<b>C<sub>COMP</sub></b>	<b>C3</b>	<b>V<sub>IN</sub> (V)</b>	<b>DROOP (mV)</b>	<b>PEAK TO PEAK (mV)</b>	<b>RECOVERY TIME (μs)</b>	<b>LOAD STEP (A/μs)</b>	<b>R<sub>SET</sub> (kΩ)</b>
1.2	2 × 10μF 25V	150μF 35V	3 × 22μF 6.3V	470μF 4V	NONE	47pF	5	70	140	30	6	60.4
1.2	2 × 10μF 25V	150μF 35V	1 × 100μF 6.3V	470μF 2.5V	NONE	100pF	5	35	70	20	6	60.4
1.2	2 × 10μF 25V	150μF 35V	2 × 100μF 6.3V	330μF 6.3V	NONE	22pF	5	70	140	20	6	60.4
1.2	2 × 10μF 25V	150μF 35V	4 × 100μF 6.3V	NONE	NONE	100pF	5	40	93	30	6	60.4
1.2	2 × 10μF 25V	150μF 35V	3 × 22μF 6.3V	470μF 4V	NONE	100pF	12	70	140	30	6	60.4
1.2	2 × 10μF 25V	150μF 35V	1 × 100μF 6.3V	470μF 2.5V	NONE	100pF	12	35	70	20	6	60.4
1.2	2 × 10μF 25V	150μF 35V	2 × 100μF 6.3V	330μF 6.3V	NONE	22pF	12	70	140	20	6	60.4
1.2	2 × 10μF 25V	150μF 35V	4 × 100μF 6.3V	NONE	NONE	100pF	12	49	98	20	6	60.4
1.5	2 × 10μF 25V	150μF 35V	3 × 22μF 6.3V	470μF 4V	NONE	100pF	5	48	100	35	6	40.2
1.5	2 × 10μF 25V	150μF 35V	1 × 100μF 6.3V	470μF 2.5V	NONE	33pF	5	54	109	30	6	40.2
1.5	2 × 10μF 25V	150μF 35V	2 × 100μF 6.3V	330μF 6.3V	NONE	100pF	5	44	84	30	6	40.2
1.5	2 × 10μF 25V	150μF 35V	4 × 100μF 6.3V	NONE	NONE	100pF	5	61	118	30	6	40.2
1.5	2 × 10μF 25V	150μF 35V	3 × 22μF 6.3V	470μF 4V	NONE	100pF	12	48	100	35	6	40.2
1.5	2 × 10μF 25V	150μF 35V	1 × 100μF 6.3V	470μF 2.5V	NONE	33pF	12	54	109	30	6	40.2
1.5	2 × 10μF 25V	150μF 35V	2 × 100μF 6.3V	330μF 6.3V	NONE	100pF	12	44	89	25	6	40.2
1.5	2 × 10μF 25V	150μF 35V	4 × 100μF 6.3V	NONE	NONE	100pF	12	54	108	25	6	40.2
1.8	2 × 10μF 25V	150μF 35V	3 × 22μF 6.3V	470μF 4V	NONE	47pF	5	48	100	30	6	30.1
1.8	2 × 10μF 25V	150μF 35V	1 × 100μF 6.3V	470μF 2.5V	NONE	100pF	5	44	90	20	6	30.1
1.8	2 × 10μF 25V	150μF 35V	2 × 100μF 6.3V	330μF 6.3V	NONE	100pF	5	68	140	30	6	30.1
1.8	2 × 10μF 25V	150μF 35V	4 × 100μF 6.3V	NONE	NONE	100pF	5	65	130	30	6	30.1
1.8	2 × 10μF 25V	150μF 35V	3 × 22μF 6.3V	470μF 4V	NONE	100pF	12	60	120	30	6	30.1
1.8	2 × 10μF 25V	150μF 35V	1 × 100μF 6.3V	470μF 2.5V	NONE	100pF	12	60	120	30	6	30.1
1.8	2 × 10μF 25V	150μF 35V	2 × 100μF 6.3V	330μF 6.3V	NONE	100pF	12	68	140	30	6	30.1
1.8	2 × 10μF 25V	150μF 35V	4 × 100μF 6.3V	NONE	NONE	100pF	12	65	130	20	6	30.1
2.5	2 × 10μF 25V	150μF 35V	1 × 100μF 6.3V	470μF 4V	NONE	100pF	5	48	103	30	6	19.1
2.5	2 × 10μF 25V	150μF 35V	2 × 100μF 6.3V	330μF 6.3V	NONE	220pF	5	56	113	30	6	19.1
2.5	2 × 10μF 25V	150μF 35V	3 × 22μF 6.3V	470μF 4V	NONE	NONE	5	57	116	30	6	19.1
2.5	2 × 10μF 25V	150μF 35V	4 × 100μF 6.3V	NONE	NONE	100pF	5	60	115	25	6	19.1
2.5	2 × 10μF 25V	150μF 35V	1 × 100μF 6.3V	470μF 4V	NONE	100pF	12	48	103	30	6	19.1
2.5	2 × 10μF 25V	150μF 35V	3 × 22μF 6.3V	470μF 4V	NONE	NONE	12	51	102	30	6	19.1
2.5	2 × 10μF 25V	150μF 35V	2 × 100μF 6.3V	330μF 6.3V	NONE	220pF	12	56	113	30	6	19.1
2.5	2 × 10μF 25V	150μF 35V	4 × 100μF 6.3V	NONE	NONE	220pF	12	70	140	25	6	19.1
3.3	2 × 10μF 25V	150μF 35V	2 × 100μF 6.3V	330μF 6.3V	NONE	100pF	7	120	240	30	6	13.3
3.3	2 × 10μF 25V	150μF 35V	1 × 100μF 6.3V	470μF 4V	NONE	100pF	7	110	214	30	6	13.3
3.3	2 × 10μF 25V	150μF 35V	3 × 22μF 6.3V	470μF 4V	NONE	100pF	7	110	214	30	6	13.3
3.3	2 × 10μF 25V	150μF 35V	4 × 100μF 6.3V	NONE	NONE	100pF	7	114	230	30	6	13.3
3.3	2 × 10μF 25V	150μF 35V	1 × 100μF 6.3V	470μF 4V	NONE	100pF	12	110	214	30	6	13.3
3.3	2 × 10μF 25V	150μF 35V	3 × 22μF 6.3V	470μF 4V	NONE	150pF	12	110	214	35	6	13.3
3.3	2 × 10μF 25V	150μF 35V	2 × 100μF 6.3V	330μF 6.3V	NONE	100pF	12	110	214	35	6	13.3
3.3	2 × 10μF 25V	150μF 35V	4 × 100μF 6.3V	NONE	NONE	100pF	12	114	230	30	6	13.3
5	2 × 10μF 25V	150μF 35V	4 × 100μF 6.3V	NONE	NONE	22pF	15	188	375	25	6	8.25
5	2 × 10μF 25V	150μF 35V	4 × 100μF 6.3V	NONE	NONE	22pF	20	159	320	25	6	8.25

## APPLICATIONS INFORMATION

**Table 3. 1.5V Output at 12A**

DERATING CURVE	V <sub>IN</sub> (V)	POWER LOSS CURVE	AIR FLOW (LFM)	HEAT SINK	$\theta_{JA}$ (°C/W) LGA	$\theta_{JA}$ (°C/W) BGA
Figures 9, 11	5, 12	Figure 7	0	None	15.2	15.7
Figures 9, 11	5, 12	Figure 7	200	None	14	14.5
Figures 9, 11	5, 12	Figure 7	400	None	12	12.5
Figures 10, 12	5, 12	Figure 7	0	BGA Heat Sink	13.9	14.4
Figures 10, 12	5, 12	Figure 7	200	BGA Heat Sink	11.3	11.8
Figures 10, 12	5, 12	Figure 7	400	BGA Heat Sink	10.25	10.75

**Table 4. 3.3V Output at 12A**

DERATING CURVE	V <sub>IN</sub> (V)	POWER LOSS CURVE	AIR FLOW (LFM)	HEAT SINK	$\theta_{JA}$ (°C/W) LGA	$\theta_{JA}$ (°C/W) BGA
Figure 13	12	Figure 8	0	None	15.2	15.7
Figure 13	12	Figure 8	200	None	14.6	15.0
Figure 13	12	Figure 8	400	None	13.4	13.9
Figure 14	12	Figure 8	0	BGA Heat Sink	13.9	14.4
Figure 14	12	Figure 8	200	BGA Heat Sink	11.1	11.6
Figure 14	12	Figure 8	400	BGA Heat Sink	10.5	11.0

**Heat Sink Manufacturer**

Aavid Thermalloy	Part No: 375424B00034G	Phone: 603-224-9988
------------------	------------------------	---------------------

## APPLICATIONS INFORMATION

### Layout Checklist/Example

The high integration of LTM4601 makes the PCB board layout very simple and easy. However, to optimize its electrical and thermal performance, some layout considerations are still necessary.

- Use large PCB copper areas for high current path, including  $V_{IN}$ , PGND and  $V_{OUT}$ . It helps to minimize the PCB conduction loss and thermal stress.
- Place high frequency ceramic input and output capacitors next to the  $V_{IN}$ , PGND and  $V_{OUT}$  pins to minimize high frequency noise.
- Place a dedicated power ground layer underneath the unit. Refer frequency synchronization source to power ground.
- To minimize the via conduction loss and reduce module thermal stress, use multiple vias for interconnection between top layer and other power layers.
- Do not put vias directly on pads unless they are capped.

- Use a separated SGND copper area for components connected to signal pins. Connect the SGND to PGND underneath the unit.

Figure 15 gives a good example of the recommended layout.

### Frequency Adjustment

The LTM4601 is designed to typically operate at 850kHz across most input conditions. The  $f_{SET}$  pin is normally left open. The switching frequency has been optimized for maintaining constant output ripple noise over most operating ranges. The 850kHz switching frequency and the 400ns minimum off time can limit operation at higher duty cycles like 5V to 3.3V, and produce excessive inductor ripple currents for lower duty cycle applications like 20V to 5V. The  $5V_{OUT}$  and  $3.3V_{OUT}$  drop out curves are modified by adding an external resistor on the  $f_{SET}$  pin to allow for lower input voltage operation, or higher input voltage operation.

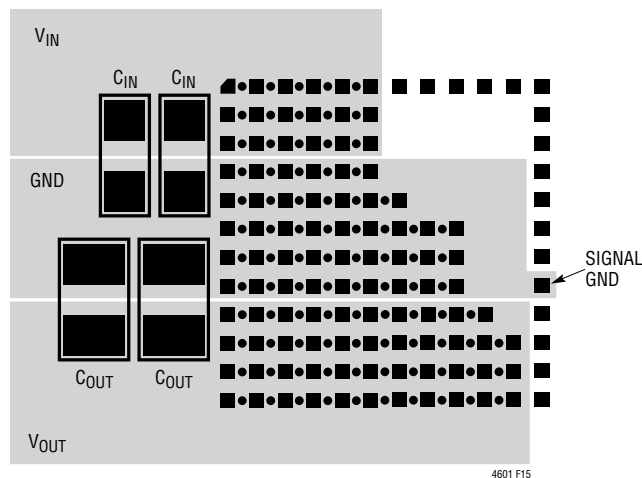

**Figure 15. Recommended Layout (LGA and BGA PCB Layouts Are Identical with the Exception of Circle Pads for BGA, See Package Description.)**

## APPLICATIONS INFORMATION

### Example for 5V Output

LTM4601 minimum on-time = 100ns

$t_{ON} = ((V_{OUT} \cdot 10pF)/I_{fSET})$ , for  $V_{OUT} > 4.8V$  use 4.8V.

LTM4601 minimum off-time = 400ns

$t_{OFF} = t - t_{ON}$ , where  $t = 1/\text{Frequency}$

Duty Cycle =  $t_{ON}/t$  or  $V_{OUT}/V_{IN}$

Equations for setting frequency:

$I_{fSET} = (V_{IN}/(3 \cdot R_{fSET}))$ , for 20V operation,  $I_{fSET} = 170\mu A$ ,  $t_{ON} = ((4.8 \cdot 10pF)/I_{fSET})$ ,  $t_{ON} = 282ns$ , where the internal  $R_{fSET}$  is 39.2k. Frequency =  $(V_{OUT}/(V_{IN} \cdot t_{ON})) = (5V/(20 \cdot 282ns)) \sim 886kHz$ . The inductor ripple current begins to get high at the higher input voltages due to a larger voltage across the inductor. This is noted in the Inductor Ripple Current vs Duty Cycle graph (Figure 3) where  $I_L \approx 10A$  at 25% duty cycle. The inductor ripple current can be lowered at the higher input voltages by adding an external resistor from  $f_{SET}$  to ground to increase the switching frequency. An 8A ripple current is chosen, and the total peak current is equal to 1/2 of the 8A ripple current plus the output current. The 5V output current is limited to 8A, so the total peak current is less than 12A. This is below the 14A peak specified value. A 100k resistor is placed from  $f_{SET}$  to ground, and the parallel combination of 100k and 39.2k equates to 28k. The  $I_{fSET}$  calculation with 28k and 20V input voltage equals  $238\mu A$ . This equates to a  $t_{ON}$  of 200ns. This will increase the switching frequency from  $\sim 886kHz$  to  $\sim 1.25MHz$  for the 20V to 5V conversion. The minimum on-time is above 100ns at 20V input. Since the switching frequency is approximately constant over input and output conditions, then the lower input voltage range is limited to 10V for the 1.25MHz operation due to the 400ns minimum off-time. Equation:  $t_{ON} = (V_{OUT}/V_{IN}) \cdot (1/\text{Frequency})$  equates to a 400ns on-time, and a 400ns off-time. The  $V_{IN}$  to  $V_{OUT}$  Step-Down Ratio curve reflects an operating range of 10V to 20V for 1.25MHz operation with a 100k resistor to ground, and an 8V to 16V operation for  $f_{SET}$  floating. These modifications are made to provide wider input voltage ranges for the 5V output designs while limiting the inductor ripple current, and maintaining the 400ns minimum off-time.

### Example for 3.3V Output

LTM4601 minimum on-time = 100ns

$t_{ON} = ((V_{OUT} \cdot 10pF)/I_{fSET})$

LTM4601 minimum off-time = 400ns

$t_{OFF} = t - t_{ON}$ , where  $t = 1/\text{Frequency}$

Duty Cycle (DC) =  $t_{ON}/t$  or  $V_{OUT}/V_{IN}$

Equations for setting frequency:

$I_{fSET} = (V_{IN}/(3 \cdot R_{fSET}))$ , for 20V operation,  $I_{fSET} = 170\mu A$ ,  $t_{ON} = ((3.3 \cdot 10pF)/I_{fSET})$ ,  $t_{ON} = 195ns$ , where the internal  $R_{fSET}$  is 39.2k. Frequency =  $(V_{OUT}/(V_{IN} \cdot t_{ON})) = (3.3V/(20 \cdot 195ns)) \sim 846kHz$ . The minimum on-time and minimum off-time are within specification at 195ns and 980ns. The 4.5V minimum input for converting 3.3V output will not meet the minimum off-time specification of 400ns.  $t_{ON} = 868ns$ , Frequency = 850kHz,  $t_{OFF} = 315ns$ .

### Solution

Lower the switching frequency at lower input voltages to allow for higher duty cycles, and meet the 400ns minimum off-time at 4.5V input voltage. The off-time should be about 500ns, which includes a 100ns guard band. The duty cycle for  $(3.3V/4.5V) = \sim 73\%$ . Frequency =  $(1 - DC)/t_{OFF}$  or  $(1 - 0.73)/500ns = 540kHz$ . The switching frequency needs to be lowered to 540kHz at 4.5V input.  $t_{ON} = DC/\text{frequency}$ , or  $1.35\mu s$ . The  $f_{SET}$  pin voltage is 1/3 of  $V_{IN}$ , and the  $I_{fSET}$  current equates to  $38\mu A$  with the internal 39.2k. The  $I_{fSET}$  current needs to be  $24\mu A$  for 540kHz operation. A resistor can be placed from  $V_{OUT}$  to  $f_{SET}$  to lower the effective  $I_{fSET}$  current out of the  $f_{SET}$  pin to  $24\mu A$ . The  $f_{SET}$  pin is  $4.5V/3 = 1.5V$  and  $V_{OUT} = 3.3V$ , therefore 130k will source  $14\mu A$  into the  $f_{SET}$  node and lower the  $I_{fSET}$  current to  $24\mu A$ . This enables the 540kHz operation and the 4.5V to 20V input operation for down converting to 3.3V output. The frequency will scale from 540kHz to 1.1 MHz over this input range. This provides for an effective output current of 8A over the input range.

## APPLICATIONS INFORMATION

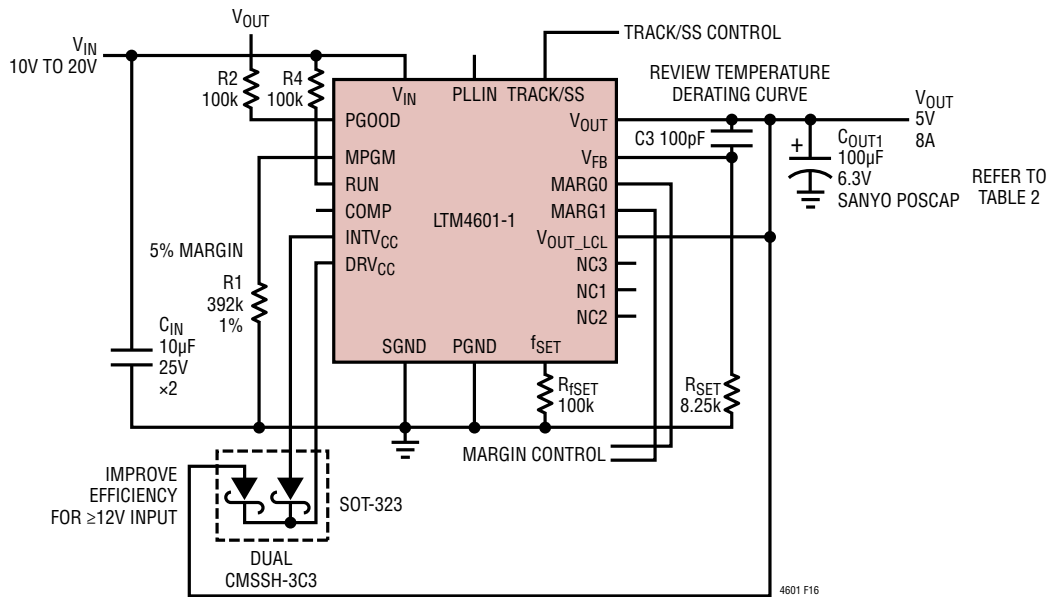

**Figure 16. 5V at 8A Design Without Differential Amplifier**

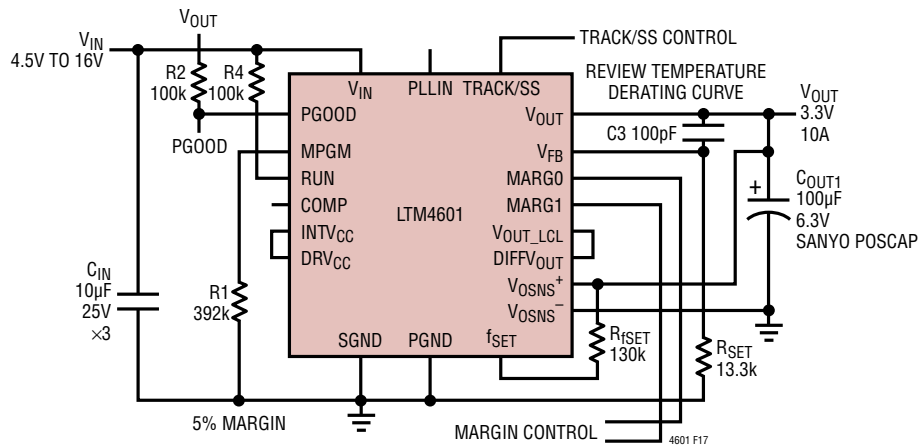

**Figure 17. 3.3V at 10A Design**



APPLICATIONS INFORMATION

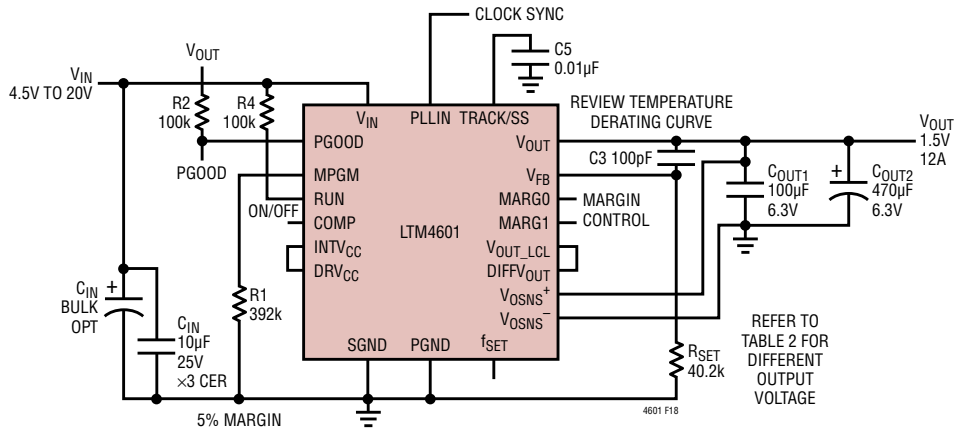

Figure 18. Typical 4.5V to 20V, 1.5V at 12A Design

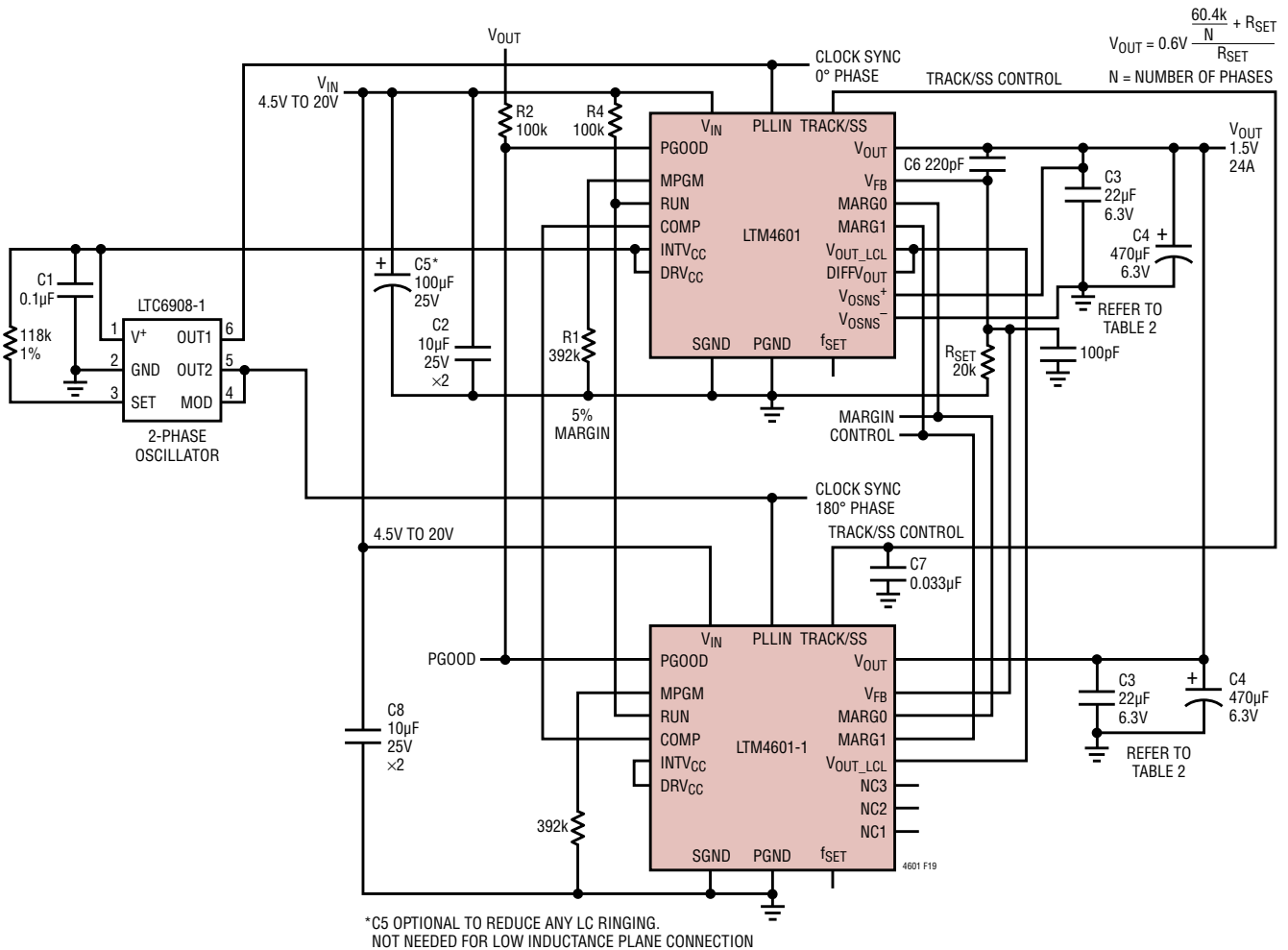

Figure 19. 2-Phase Parallel, 1.5V at 24A Design



# PACKAGE DESCRIPTION

Please refer to <http://www.linear.com/designtools/packaging/> for the most recent package drawings.

**LGA Package**  
**118-Lead (15mm × 15mm × 2.82mm)**  
 (Reference LTC DWG # 05-08-1801 Rev B)

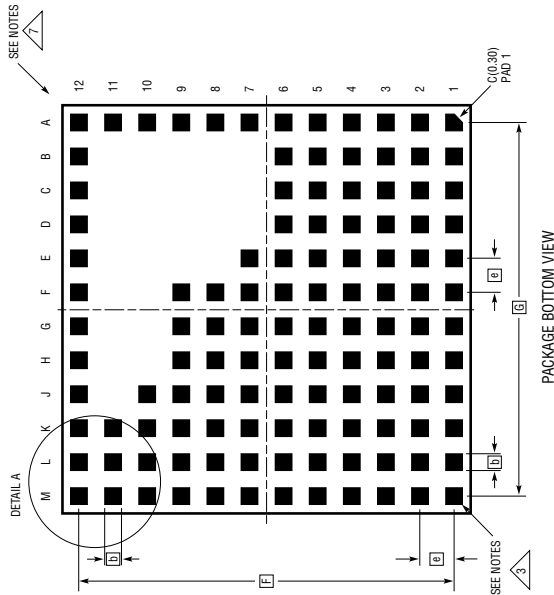

- NOTES:**
1. DIMENSIONING AND TOLERANCING PER ASME Y14.5M-1994
  2. ALL DIMENSIONS ARE IN MILLIMETERS
  3. LAND DESIGNATION PER JEDEC MO-222, SPP-010
  4. DETAILS OF PAD #1 IDENTIFIER ARE OPTIONAL, BUT MUST BE LOCATED WITHIN THE ZONE INDICATED. THE PAD #1 IDENTIFIER MAY BE EITHER A MOLD OR MARKED FEATURE
  5. PRIMARY DATUM -Z- IS SEATING PLANE
  6. THE TOTAL NUMBER OF PADS: 118
  7. PACKAGE ROW AND COLUMN LABELING MAY VARY AMONG  $\mu$ Module PRODUCTS. REVIEW EACH PACKAGE LAYOUT CAREFULLY

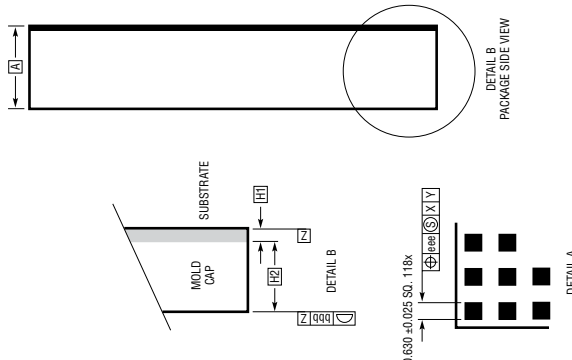
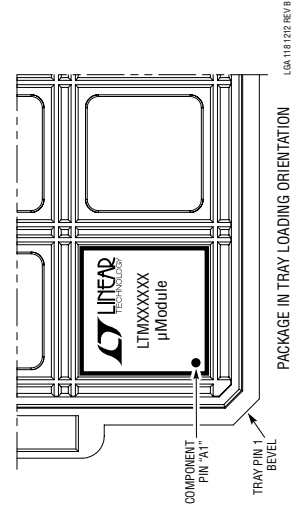

DIMENSIONS				
SYMBOL	MIN	NOM	MAX	NOTES
A	2.72	2.82	2.92	
b	0.60	0.63	0.66	
D		15.00		
E		15.00		
e		1.27		
F		13.97		
G		13.97		
H1	0.27	0.32	0.37	
H2	2.45	2.50	2.55	
aaa		0.15		
bbb		0.10		
eee		0.05		
TOTAL NUMBER OF LGA PADS: 118				

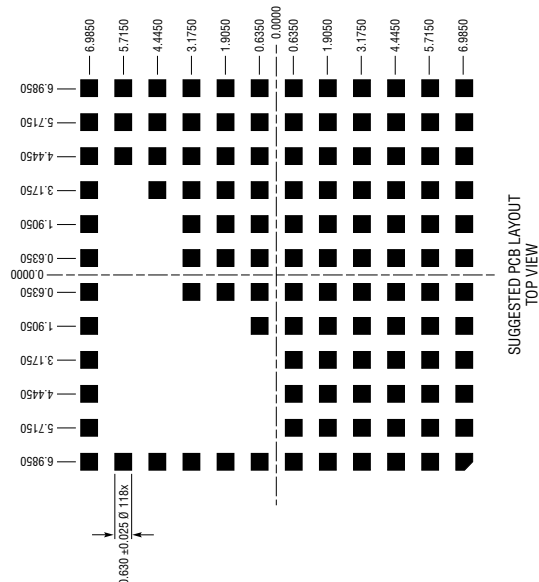
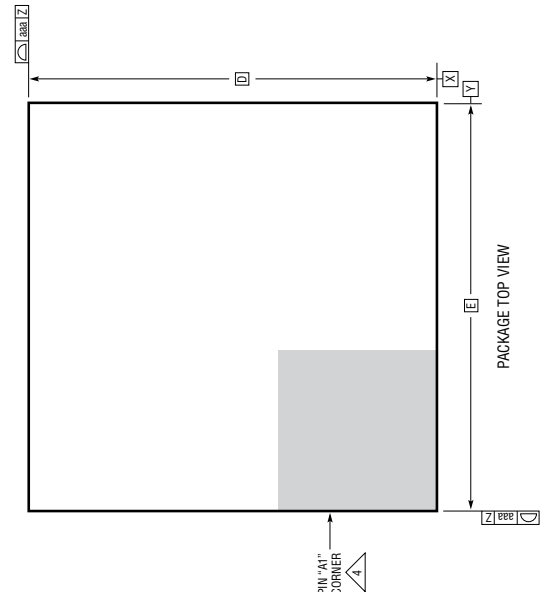

# PACKAGE DESCRIPTION

Please refer to <http://www.linear.com/designtools/packaging/> for the most recent package drawings.

**BGA Package**  
**118-Lead (15mm × 15mm × 3.42mm)**  
 (Reference LTC DWG # 05-08-1903 Rev B)

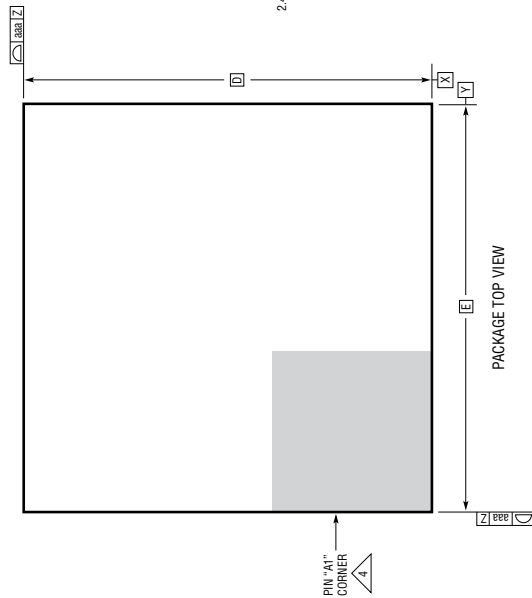
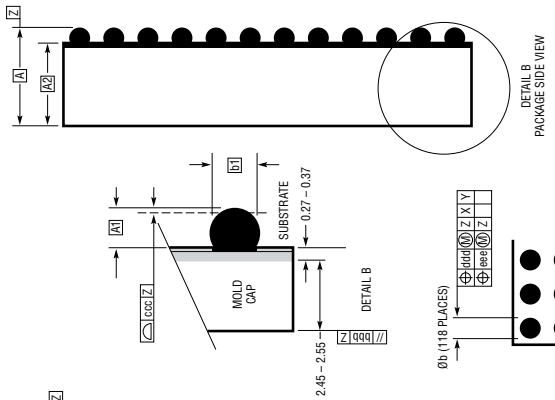
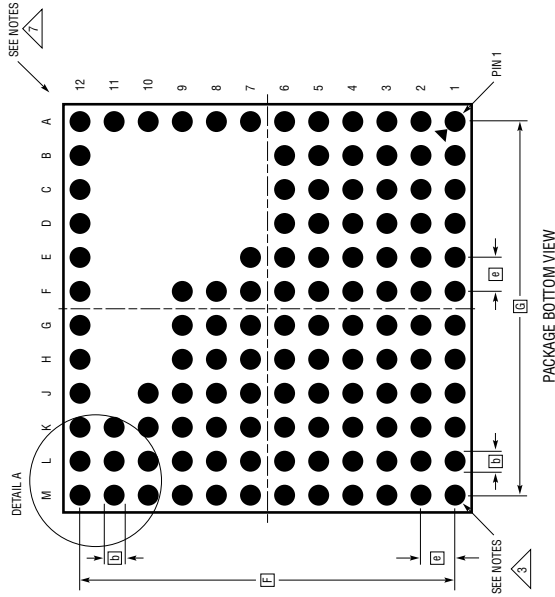

- NOTES:
1. DIMENSIONING AND TOLERANCING PER ASME Y14.5M-1994
  2. ALL DIMENSIONS ARE IN MILLIMETERS
  3. BALL DESIGNATION PER JEDEC MS-028 AND JEP95
  4. DETAILS OF PIN #1 IDENTIFIER ARE OPTIONAL, BUT MUST BE LOCATED WITHIN THE ZONE INDICATED. THE PIN #1 IDENTIFIER MAY BE EITHER A MOLD OR MARKED FEATURE
  5. PRIMARY DATUM -Z- IS SEATING PLANE
  6. SOLDER BALL COMPOSITION IS 96.5% Sn/3.0% Ag/0.5% Cu
  7. PACKAGE ROW AND COLUMN LABELING MAY VARY AMONG  $\mu$ Module PRODUCTS. REVIEW EACH PACKAGE LAYOUT CAREFULLY

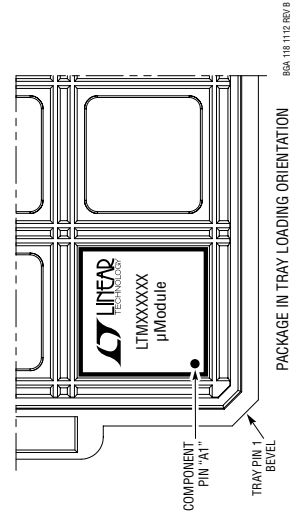

DIMENSIONS				
SYMBOL	MIN	NOM	MAX	NOTES
A	3.22	3.42	3.62	
A1	0.50	0.60	0.70	
A2	2.72	2.82	2.92	
b	0.60	0.75	0.90	
b1	0.60	0.63	0.66	
D		15.0		
E		15.0		
e		1.27		
F		13.97		
G		13.97		
aaa			0.15	
bbb			0.10	
ccc			0.20	
ddd			0.30	
eee			0.15	
				TOTAL NUMBER OF BALLS: 118

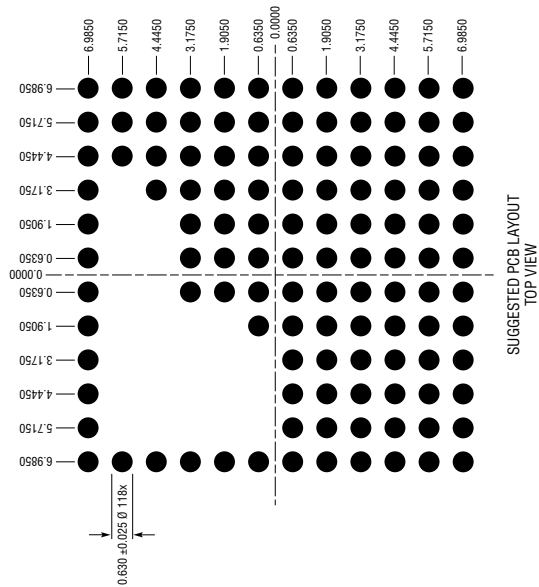

## PACKAGE DESCRIPTION

Table 5. Pin Assignment (Arranged by Pin Number)

PIN ID	FUNCTION	PIN ID	FUNCTION	PIN ID	FUNCTION	PIN ID	FUNCTION	PIN ID	FUNCTION	PIN ID	FUNCTION
A1	V <sub>IN</sub>	B1	V <sub>IN</sub>	C1	V <sub>IN</sub>	D1	PGND	E1	PGND	F1	PGND
A2	V <sub>IN</sub>	B2	V <sub>IN</sub>	C2	V <sub>IN</sub>	D2	PGND	E2	PGND	F2	PGND
A3	V <sub>IN</sub>	B3	V <sub>IN</sub>	C3	V <sub>IN</sub>	D3	PGND	E3	PGND	F3	PGND
A4	V <sub>IN</sub>	B4	V <sub>IN</sub>	C4	V <sub>IN</sub>	D4	PGND	E4	PGND	F4	PGND
A5	V <sub>IN</sub>	B5	V <sub>IN</sub>	C5	V <sub>IN</sub>	D5	PGND	E5	PGND	F5	PGND
A6	V <sub>IN</sub>	B6	V <sub>IN</sub>	C6	V <sub>IN</sub>	D6	PGND	E6	PGND	F6	PGND
A7	INTV <sub>CC</sub>	B7	–	C7	–	D7	–	E7	PGND	F7	PGND
A8	PLLIN	B8	–	C8	–	D8	–	E8	–	F8	PGND
A9	TRACK/SS	B9	–	C9	–	D9	–	E9	–	F9	PGND
A10	RUN	B10	–	C10	–	D10	–	E10	–	F10	–
A11	COMP	B11	–	C11	–	D11	–	E11	–	F11	–
A12	MPGM	B12	f <sub>SET</sub>	C12	MARG0	D12	MARG1	E12	DRV <sub>CC</sub>	F12	V <sub>FB</sub>

PIN ID	FUNCTION	PIN ID	FUNCTION	PIN ID	FUNCTION	PIN ID	FUNCTION	PIN ID	FUNCTION	PIN ID	FUNCTION
G1	PGND	H1	PGND	J1	V <sub>OUT</sub>	K1	V <sub>OUT</sub>	L1	V <sub>OUT</sub>	M1	V <sub>OUT</sub>
G2	PGND	H2	PGND	J2	V <sub>OUT</sub>	K2	V <sub>OUT</sub>	L2	V <sub>OUT</sub>	M2	V <sub>OUT</sub>
G3	PGND	H3	PGND	J3	V <sub>OUT</sub>	K3	V <sub>OUT</sub>	L3	V <sub>OUT</sub>	M3	V <sub>OUT</sub>
G4	PGND	H4	PGND	J4	V <sub>OUT</sub>	K4	V <sub>OUT</sub>	L4	V <sub>OUT</sub>	M4	V <sub>OUT</sub>
G5	PGND	H5	PGND	J5	V <sub>OUT</sub>	K5	V <sub>OUT</sub>	L5	V <sub>OUT</sub>	M5	V <sub>OUT</sub>
G6	PGND	H6	PGND	J6	V <sub>OUT</sub>	K6	V <sub>OUT</sub>	L6	V <sub>OUT</sub>	M6	V <sub>OUT</sub>
G7	PGND	H7	PGND	J7	V <sub>OUT</sub>	K7	V <sub>OUT</sub>	L7	V <sub>OUT</sub>	M7	V <sub>OUT</sub>
G8	PGND	H8	PGND	J8	V <sub>OUT</sub>	K8	V <sub>OUT</sub>	L8	V <sub>OUT</sub>	M8	V <sub>OUT</sub>
G9	PGND	H9	PGND	J9	V <sub>OUT</sub>	K9	V <sub>OUT</sub>	L9	V <sub>OUT</sub>	M9	V <sub>OUT</sub>
G10	–	H10	–	J10	V <sub>OUT</sub>	K10	V <sub>OUT</sub>	L10	V <sub>OUT</sub>	M10	V <sub>OUT</sub>
G11	–	H11	–	J11	–	K11	V <sub>OUT</sub>	L11	V <sub>OUT</sub>	M11	V <sub>OUT</sub>
G12	PGOOD	H12	SGND	J12	V <sub>OSNS+</sub> /NC2*	K12	DIFFV <sub>OUT</sub> /NC2*	L12	V <sub>OUT_LCL</sub>	M12	V <sub>OSNS-</sub> /NC1*

\*LTM4601-1 Only

## PACKAGE DESCRIPTION

Table 6. Pin Assignment (Arranged by Pin Function)

PIN NAME		PIN NAME		PIN NAME		PIN NAME		PIN NAME	
A1	V <sub>IN</sub>	D1	PGND	J1	V <sub>OUT</sub>	A7	INTVCC	B7	-
A2	V <sub>IN</sub>	D2	PGND	J2	V <sub>OUT</sub>	A8	PLLIN	B8	-
A3	V <sub>IN</sub>	D3	PGND	J3	V <sub>OUT</sub>	A9	TRACK/SS	B9	-
A4	V <sub>IN</sub>	D4	PGND	J4	V <sub>OUT</sub>	A10	RUN	B10	-
A5	V <sub>IN</sub>	D5	PGND	J5	V <sub>OUT</sub>	A11	COMP	B11	-
A6	V <sub>IN</sub>	D6	PGND	J6	V <sub>OUT</sub>	A12	MPGM		
				J7	V <sub>OUT</sub>			C7	-
B1	V <sub>IN</sub>	E1	PGND	J8	V <sub>OUT</sub>	B12	f <sub>SET</sub>	C8	-
B2	V <sub>IN</sub>	E2	PGND	J9	V <sub>OUT</sub>	C12	MARG0	C9	-
B3	V <sub>IN</sub>	E3	PGND	J10	V <sub>OUT</sub>	D12	MARG1	C10	-
B4	V <sub>IN</sub>	E4	PGND			E12	DRV <sub>CC</sub>	C11	-
B5	V <sub>IN</sub>	E5	PGND	K1	V <sub>OUT</sub>	F12	V <sub>FB</sub>	D7	-
B6	V <sub>IN</sub>	E6	PGND	K2	V <sub>OUT</sub>	G12	PGOOD	D8	-
		E7	PGND	K3	V <sub>OUT</sub>	H12	SGND	D9	-
C1	V <sub>IN</sub>	F1	PGND	K4	V <sub>OUT</sub>	J12	V <sub>OSNS</sub> <sup>+</sup> /NC2*	D10	-
C2	V <sub>IN</sub>	F2	PGND	K5	V <sub>OUT</sub>	K12	DIFFV <sub>OUT</sub> /NC3*	D11	-
C3	V <sub>IN</sub>	F3	PGND	K6	V <sub>OUT</sub>	L12	V <sub>OUT_LCL</sub>	E8	-
C4	V <sub>IN</sub>	F4	PGND	K7	V <sub>OUT</sub>	M12	V <sub>OSNS</sub> <sup>-</sup> /NC1*	E9	-
C5	V <sub>IN</sub>	F5	PGND	K8	V <sub>OUT</sub>			E10	-
C6	V <sub>IN</sub>	F6	PGND	K9	V <sub>OUT</sub>			E11	-
		F7	PGND	K10	V <sub>OUT</sub>			F10	-
		F8	PGND	K11	V <sub>OUT</sub>			F11	-
		F9	PGND					G10	-
		G1	PGND	L1	V <sub>OUT</sub>			G11	-
		G2	PGND	L2	V <sub>OUT</sub>			H10	-
		G3	PGND	L3	V <sub>OUT</sub>			H11	-
		G4	PGND	L4	V <sub>OUT</sub>			J11	-
		G5	PGND	L5	V <sub>OUT</sub>				
		G6	PGND	L6	V <sub>OUT</sub>				
		G7	PGND	L7	V <sub>OUT</sub>				
		G8	PGND	L8	V <sub>OUT</sub>				
		G9	PGND	L9	V <sub>OUT</sub>				
				L10	V <sub>OUT</sub>				
		H1	PGND	L11	V <sub>OUT</sub>				
		H2	PGND						
		H3	PGND	M1	V <sub>OUT</sub>				
		H4	PGND	M2	V <sub>OUT</sub>				
		H5	PGND	M3	V <sub>OUT</sub>				
		H6	PGND	M4	V <sub>OUT</sub>				
		H7	PGND	M5	V <sub>OUT</sub>				
		H8	PGND	M6	V <sub>OUT</sub>				
		H9	PGND	M7	V <sub>OUT</sub>				
				M8	V <sub>OUT</sub>				
				M9	V <sub>OUT</sub>				
				M10	V <sub>OUT</sub>				
				M11	V <sub>OUT</sub>				

\*LTM4601-1 Only

**REVISION HISTORY** (Revision history begins at Rev B)

REV	DATE	DESCRIPTION	PAGE NUMBER
B	01/10	Added Note 5	2, 4
C	03/12	Revised entire data sheet to include the BGA package.	1 to 30
D	02/14	Added SnPb BGA option	1, 2
E	04/14	Added LTM4601-1 BGA package diagram and package information	2



# LTM4601

## PACKAGE PHOTO

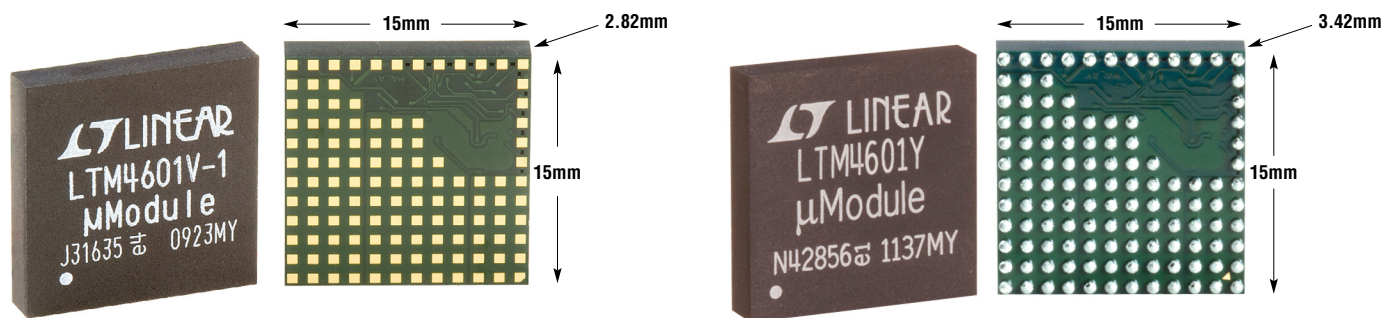

## RELATED PARTS

PART NUMBER	DESCRIPTION	COMMENTS
<a href="#">LTM4628</a>	26V, Dual 8A, DC/DC Step-Down μModule Regulator	$4.5V \leq V_{IN} \leq 26.5V$ , $0.6V \leq V_{OUT} \leq 5V$ , Remote Sense Amplifier, Internal Temperature Sensing Output, 15mm × 15mm × 4.32mm LGA
<a href="#">LTM4627</a>	20V, 15A DC/DC Step-Down μModule Regulator	$4.5V \leq V_{IN} \leq 20V$ , $0.6V \leq V_{OUT} \leq 5V$ , PLL Input, $V_{OUT}$ Tracking, Remote Sense Amplifier, 15mm × 15mm × 4.32mm LGA
<a href="#">LTM4611</a>	1.5V <sub>IN(MIN)</sub> , 15A DC/DC Step-Down μModule Regulator	$1.5V \leq V_{IN} \leq 5.5V$ , $0.8V \leq V_{OUT} \leq 5V$ , PLL Input, Remote Sense Amplifier, $V_{OUT}$ Tracking, 15mm × 15mm × 4.32mm LGA
<a href="#">LTM4613</a>	8A EN55022 Class B DC/DC Step-Down μModule Regulator	$5V \leq V_{IN} \leq 36V$ , $3.3V \leq V_{OUT} \leq 15V$ , PLL Input, $V_{OUT}$ Tracking and Margining, 15mm × 15mm × 4.32mm LGA
<a href="#">LTM4601AHV</a>	28V, 12A DC/DC Step-Down μModule Regulator	$4.5V \leq V_{IN} \leq 28V$ , $0.6V \leq V_{OUT} \leq 5V$ , PLL Input, Remote Sense Amplifier, $V_{OUT}$ Tracking and Margining, 15mm × 15mm × 2.82mm LGA or 15mm × 15mm × 3.42mm BGA
<a href="#">LTM4601A</a>	20V, 12A DC/DC Step-Down μModule Regulator	$4.5V \leq V_{IN} \leq 20V$ , $0.6V \leq V_{OUT} \leq 5V$ , PLL Input, Remote Sense Amplifier, $V_{OUT}$ Tracking and Margining, 15mm × 15mm × 2.82mm LGA or 15mm × 15mm × 3.42mm BGA
<a href="#">LTM8027</a>	60V, 4A DC/DC Step-Down μModule Regulator	$4.5V \leq V_{IN} \leq 60V$ , $2.5V \leq V_{OUT} \leq 24V$ , CLK Input, 15mm × 15mm × 4.32mm LGA
<a href="#">LTM8032</a>	36V, 2A EN55022 Class B DC/DC Step-Down μModule Regulator	$3.6V \leq V_{IN} \leq 36V$ , $0.8V \leq V_{OUT} \leq 10V$ , Synchronizable, 9mm × 15mm × 2.82mm LGA or 9mm × 15mm × 3.42mm BGA
<a href="#">LTM8061</a>	32V, 2A Step-Down μModule Battery Charger with Programmable Input Current Limit	Compatible with Single Cell or Dual Cell Li-Ion or Li-Poly Battery Stacks (4.1V, 4.2V, 8.2V, or 8.4V), $4.95V \leq V_{IN} \leq 32V$ , C/10 or Adjustable Timer Charge Termination, NTC Resistor Monitor Input, 9mm × 15mm × 4.32mm LGA

This product contains technology licensed from Silicon Semiconductor Corporation. Silicon Semiconductor® 4601fe