

FEATURES

- **Smallest Pin-Compatible Dual DACs:**
 LTC2602: 16-Bits
 LTC2612: 14-Bits
 LTC2622: 12-Bits
- **Guaranteed 16-Bit Monotonic Over Temperature**
- Wide 2.5V to 5.5V Supply Range
- Low Power Operation: 300 μ A per DAC at 3V
- Individual Channel Power-Down to 1 μ A, Max
- Ultralow Crosstalk between DACs (30 μ V)
- High Rail-to-Rail Output Drive (\pm 15mA)
- Double-Buffered Data Latches
- Pin-Compatible 10-Bit Version (LTC1661)
- Tiny 8-Lead MSOP Package

APPLICATIONS

- Mobile Communications
- Process Control and Industrial Automation
- Instrumentation
- Automatic Test Equipment

DESCRIPTION

The LTC[®]2602/LTC2612/LTC2622 are dual 16-, 14- and 12-bit, 2.5V-to-5.5V rail-to-rail voltage-output DACs, in a tiny 8-lead MSOP package. They have built-in high performance output buffers and are guaranteed monotonic.

These parts establish advanced performance standards for output drive, crosstalk and load regulation in single-supply, voltage output multiples.

The parts use a simple SPI/MICROWIRE[™] compatible 3-wire serial interface which can be operated at clock rates up to 50MHz.

The LTC2602/LTC2612/LTC2622 incorporate a power-on reset circuit. During power-up, the voltage outputs rise less than 10mV above zero scale, and after power-up, they stay at zero scale until a valid write and update take place.

LTC, LTC and LT are registered trademarks of Linear Technology Corporation. All other trademarks are the property of their respective owners.

BLOCK DIAGRAM

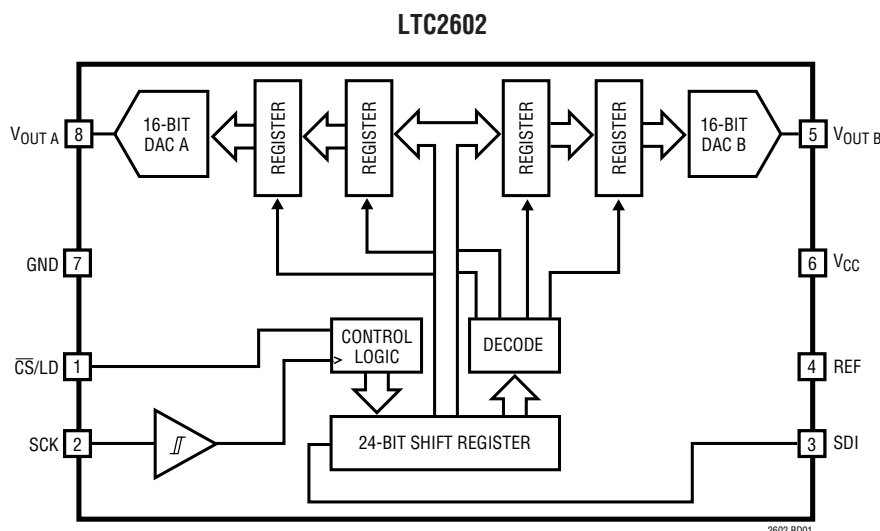

Differential Nonlinearity (DNL)(LTC2602)

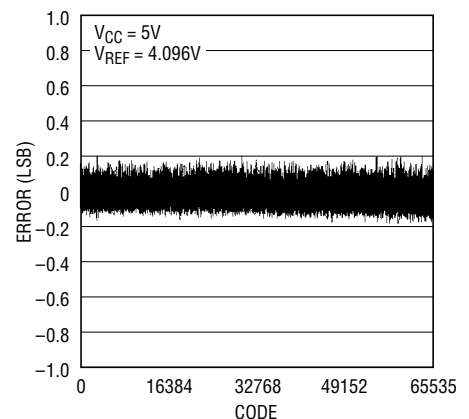

ABSOLUTE MAXIMUM RATINGS

(Note 1)

Any Pin to GND	-0.3V to 6V
Any Pin to V_{CC}	-6V to 0.3V
Maximum Junction Temperature	125°C
Operating Temperature Range	
LTC2602C/LTC2612C/LTC2622C	0°C to 70°C
LTC2602I/LTC2612I/LTC2622I	-40°C to 85°C
Storage Temperature Range	-65°C to 150°C
Lead Temperature (Soldering, 10 sec).....	300°C

PACKAGE/ORDER INFORMATION

TOP VIEW

MS8 PACKAGE
8-LEAD PLASTIC MSOP
 $T_{JMAX} = 125^{\circ}\text{C}$, $\theta_{JA} = 300^{\circ}\text{C/W}$

ORDER PART NUMBER	MS8 PART MARKING
LTC2602CMS8	LTACX
LTC2602IMS8	LTACY
LTC2612CMS8	LTACZ
LTC2612IMS8	LTADA
LTC2622CMS8	LTADB
LTC2622IMS8	LTADC

Order Options Tape and Reel: Add #TR
 Lead Free: Add #PBF Lead Free Tape and Reel: Add #TRPBF
 Lead Free Part Marking: <http://www.linear.com/leadfree/>

Consult LTC Marketing for parts specified with wider operating temperature ranges.

ELECTRICAL CHARACTERISTICS

The ● denotes specifications which apply over the full operating temperature range, otherwise specifications are at $T_A = 25^{\circ}\text{C}$. $V_{CC} = 2.5\text{V}$ to 5.5V , $V_{REF} \leq V_{CC}$, V_{OUT} unloaded, unless otherwise noted.

SYMBOL	PARAMETER	CONDITIONS	LTC2622			LTC2612			LTC2602			UNITS
			MIN	TYP	MAX	MIN	TYP	MAX	MIN	TYP	MAX	
DC Performance												
	Resolution		●	12		14		16				Bits
	Monotonicity	$V_{CC} = 5\text{V}$, $V_{REF} = 4.096\text{V}$ (Note 2)	●	12		14		16				Bits
DNL	Differential Nonlinearity	$V_{CC} = 5\text{V}$, $V_{REF} = 4.096\text{V}$ (Note 2)	●		± 0.5		± 1		± 1			LSB
INL	Integral Nonlinearity	$V_{CC} = 5\text{V}$, $V_{REF} = 4.096\text{V}$ (Note 2)	●	± 0.75	± 4	± 3	± 16	± 12	± 64			LSB
	Load Regulation	$V_{REF} = V_{CC} = 5\text{V}$, Midscale $I_{OUT} = 0\text{mA}$ to 15mA Sourcing	●	0.025	0.125	0.1	0.5	0.4	2			LSB/mA
		$I_{OUT} = 0\text{mA}$ to 15mA Sinking	●	0.05	0.125	0.2	0.5	0.65	2			LSB/mA
		$V_{REF} = V_{CC} = 2.5\text{V}$, Midscale $I_{OUT} = 0\text{mA}$ to 7.5mA Sourcing	●	0.05	0.25	0.2	1	0.9	4			LSB/mA
		$I_{OUT} = 0\text{mA}$ to 7.5mA Sinking	●	0.1	0.25	0.4	1	1.3	4			LSB/mA
ZSE	Zero-Scale Error	$V_{CC} = 5\text{V}$, $V_{REF} = 4.096\text{V}$ Code = 0	●	1	9	1	9	1	9			mV
V_{OS}	Offset Error	$V_{CC} = 5\text{V}$, $V_{REF} = 4.096\text{V}$ (Note 7)	●	± 1	± 9	± 1	± 9	± 1	± 9			mV
	V_{OS} Temperature Coefficient			± 5		± 5		± 5				$\mu\text{V}/^{\circ}\text{C}$
GE	Gain Error	$V_{CC} = 5\text{V}$, $V_{REF} = 4.096\text{V}$	●	± 0.1	± 0.7	± 0.1	± 0.7	± 0.1	± 0.7			%FSR
	Gain Temperature Coefficient			± 3		± 3		± 3				$\text{ppm}/^{\circ}\text{C}$

ELECTRICAL CHARACTERISTICS

The ● denotes specifications which apply over the full operating temperature range, otherwise specifications are at $T_A = 25^\circ\text{C}$. $V_{CC} = 2.5\text{V}$ to 5.5V , $V_{REF} \leq V_{CC}$, V_{OUT} unloaded, unless otherwise noted.

SYMBOL	PARAMETER	CONDITIONS	LTC2602/LTC2612/LTC2622			UNITS	
			MIN	TYP	MAX		
PSRR	Power Supply Rejection Ratio	$V_{CC} = 5\text{V} \pm 10\%$		-80		dB	
R_{OUT}	DC Output Impedance	$V_{REF} = V_{CC} = 5\text{V}$, Midscale; $-15\text{mA} \leq I_{OUT} \leq 15\text{mA}$	●	0.05	0.15	Ω	
		$V_{REF} = V_{CC} = 2.5\text{V}$, Midscale; $-7.5\text{mA} \leq I_{OUT} \leq 7.5\text{mA}$	●	0.05	0.15	Ω	
	DC Crosstalk (Note 4)	Due to Full Scale Output Change (Note 5) Due to Load Current Change Due to Powering Down (per Channel)		± 30 ± 16 ± 4		μV $\mu\text{V}/\text{mA}$ μV	
I_{SC}	Short-Circuit Output Current	$V_{CC} = 5.5\text{V}$, $V_{REF} = 5.5\text{V}$					
		Code: Zero Scale; Forcing Output to V_{CC}	●	15	34	60	mA
		Code: Full Scale; Forcing Output to GND	●	15	38	60	mA
		$V_{CC} = 2.5\text{V}$, $V_{REF} = 2.5\text{V}$					
		Code: Zero Scale; Forcing Output to V_{CC}	●	7.5	20	50	mA
		Code: Full Scale; Forcing Output to GND	●	7.5	28	50	mA

Reference Input

	Input Voltage Range		●	0	V_{CC}	V	
	Resistance	Normal Mode	●	44	64	80	k Ω
	Capacitance				23	pF	
I_{REF}	Reference Current, Power Down Mode	All DACs Powered Down	●	0.001	1	μA	

Power Supply

V_{CC}	Positive Supply Voltage	For Specified Performance	●	2.5	5.5	V	
I_{CC}	Supply Current	$V_{CC} = 5\text{V}$ (Note 3)	●		0.7	1.3	mA
		$V_{CC} = 3\text{V}$ (Note 3)	●		0.6	1	mA
		All DACs Powered Down (Note 3) $V_{CC} = 5\text{V}$	●		0.35	1	μA
		All DACs Powered Down (Note 3) $V_{CC} = 3\text{V}$	●		0.10	1	μA

Digital I/O

V_{IH}	Digital Input High Voltage	$V_{CC} = 2.5\text{V}$ to 5.5V	●	2.4		V
		$V_{CC} = 2.5\text{V}$ to 3.6V	●	2.0		V
V_{IL}	Digital Input Low Voltage	$V_{CC} = 4.5\text{V}$ to 5.5V	●		0.8	V
		$V_{CC} = 2.7\text{V}$ to 5.5V	●		0.6	V
		$V_{CC} = 2.5\text{V}$ to 5.5V	●		0.5	V
I_{LK}	Digital Input Leakage	$V_{IN} = \text{GND}$ to V_{CC}	●		± 1	μA
C_{IN}	Digital Input Capacitance	(Note 6)	●		8	pF

SYMBOL	PARAMETER	CONDITIONS	LTC2622			LTC2612			LTC2602			UNITS
			MIN	TYP	MAX	MIN	TYP	MAX	MIN	TYP	MAX	
t_s	Settling Time (Note 8)	$\pm 0.024\%$ ($\pm 1\text{LSB}$ at 12 Bits)		7		7		7			μs	
		$\pm 0.006\%$ ($\pm 1\text{LSB}$ at 14 Bits)				9		9			μs	
		$\pm 0.0015\%$ ($\pm 1\text{LSB}$ at 16 Bits)						10			μs	
	Settling Time for 1LSB Step (Note 9)	$\pm 0.024\%$ ($\pm 1\text{LSB}$ at 12 Bits)		2.7		2.7		2.7			μs	
		$\pm 0.006\%$ ($\pm 1\text{LSB}$ at 14 Bits)				4.8		4.8			μs	
		$\pm 0.0015\%$ ($\pm 1\text{LSB}$ at 16 Bits)						5.2			μs	
	Voltage Output Slew Rate			0.80		0.80		0.80			V/ μs	
	Capacitive Load Driving			1000		1000		1000			pF	
	Glitch Impulse	At Midscale Transition		12		12		12			nV \cdot s	
	Multiplying Bandwidth			180		180		180			kHz	
e_n	Output Voltage Noise Density	At $f = 1\text{kHz}$		120		120		120			nV/ $\sqrt{\text{Hz}}$	
		At $f = 10\text{kHz}$		100		100		100			nV/ $\sqrt{\text{Hz}}$	
	Output Voltage Noise	0.1Hz to 10Hz		15		15		15			μV_{P-P}	

TIMING CHARACTERISTICS

The ● denotes specifications which apply over the full operating temperature range, otherwise specifications are at $T_A = 25^\circ\text{C}$. (See Figure 1) (Note 6)

SYMBOL	PARAMETER	CONDITIONS	LTC2602/LTC2612/LTC2622			UNITS
			MIN	TYP	MAX	
$V_{CC} = 2.5\text{V to }5.5\text{V}$						
t_1	SDI Valid to SCK Setup		●	4		ns
t_2	SDI Valid to SCK Hold		●	4		ns
t_3	SCK High Time		●	9		ns
t_4	SCK Low Time		●	9		ns
t_5	$\overline{\text{CS}}/\text{LD}$ Pulse Width		●	10		ns
t_6	LSB SCK High to $\overline{\text{CS}}/\text{LD}$ High		●	7		ns
t_7	$\overline{\text{CS}}/\text{LD}$ Low to SCK High		●	7		ns
t_{10}	$\overline{\text{CS}}/\text{LD}$ High to SCK Positive Edge		●	7		ns
	SCK Frequency	50% Duty Cycle	●		50	MHz

Note 1: Absolute maximum ratings are those values beyond which the life of a device may be impaired.

Note 2: Linearity and monotonicity are defined from code k_L to code $2^N - 1$, where N is the resolution and k_L is given by $k_L = 0.016(2^N/V_{REF})$, rounded to the nearest whole code. For $V_{REF} = 4.096\text{V}$ and $N = 16$, $k_L = 256$ and linearity is defined from code 256 to code 65,535.

Note 3: Digital inputs at 0V or V_{CC} .

Note 4: DC crosstalk is measured with $V_{CC} = 5\text{V}$ and $V_{REF} = 4.096\text{V}$, with the measured DAC at midscale, unless otherwise noted.

Note 5: $R_L = 2\text{k}\Omega$ to GND or V_{CC} at the output of the DAC not being tested.

Note 6: Guaranteed by design and not production tested.

Note 7: Inferred from measurement at code 256 (LTC2602), code 64 (LTC2612) or code 16 (LTC2622), and at fullscale.

Note 8: $V_{CC} = 5\text{V}$, $V_{REF} = 4.096\text{V}$. DAC is stepped 1/4 scale to 3/4 scale and 3/4 scale to 1/4 scale. Load is 2k in parallel with 200pF to GND.

Note 9: $V_{CC} = 5\text{V}$, $V_{REF} = 4.096\text{V}$. DAC is stepped $\pm\text{LSB}$ between half scale and half scale -1. Load is 2k in parallel with 200pF to GND.

TYPICAL PERFORMANCE CHARACTERISTICS

(LTC2602)

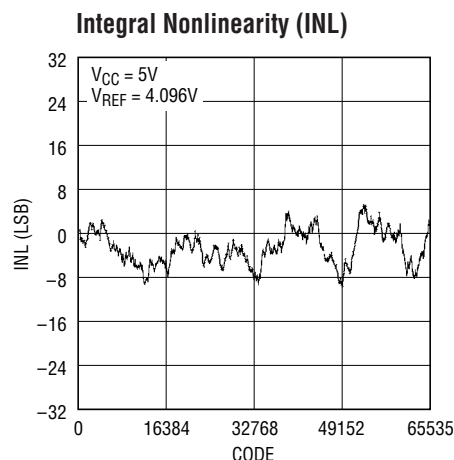

2602 G20

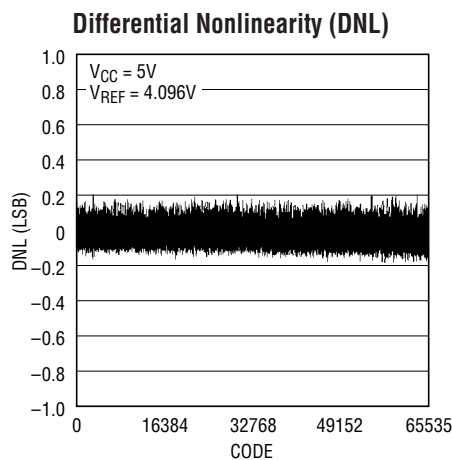

2602 G21

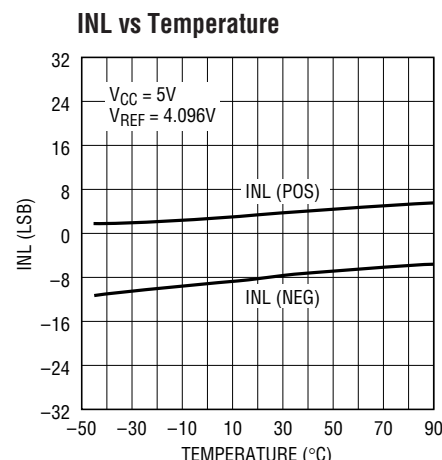

2602 G22

2602fa

TYPICAL PERFORMANCE CHARACTERISTICS

(LTC2602)

DNL vs Temperature

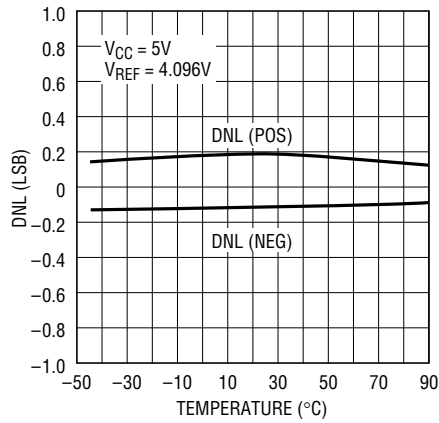

2602 G23

INL vs VREF

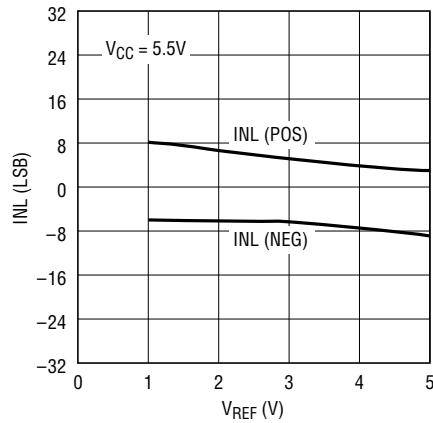

2602 G24

DNL vs VREF

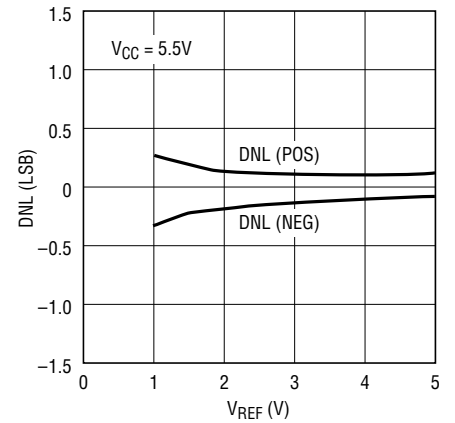

2602 G25

Settling to ±1LSB

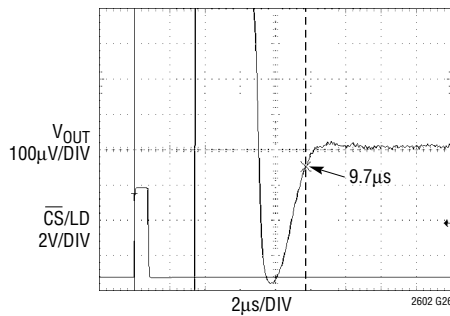

2602 G26

$V_{CC} = 5V$, $V_{REF} = 4.096V$
1/4-SCALE TO 3/4-SCALE STEP
 $R_L = 2k$, $C_L = 200pF$
AVERAGE OF 2048 EVENTS

Settling of Full-Scale Step

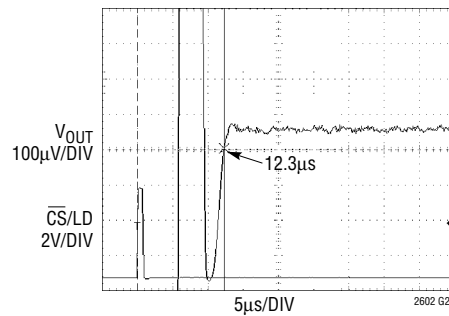

2602 G27

$V_{CC} = 5V$, $V_{REF} = 4.096V$
CODE 512 TO 65535 STEP
AVERAGE OF 2048 EVENTS
SETTLING TO ±1LSB

(LTC2612)

Integral Nonlinearity (INL)

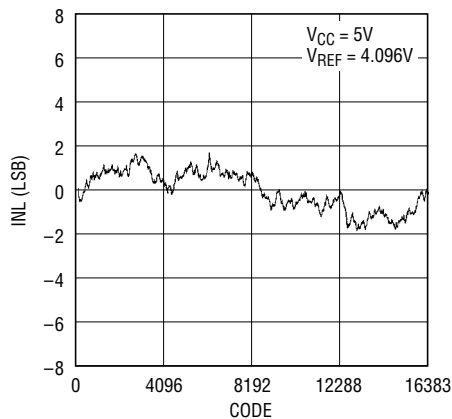

2602 G28

Differential Nonlinearity (DNL)

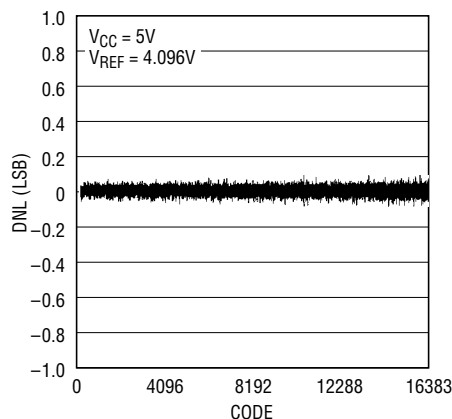

2602 G29

Settling to ±1LSB

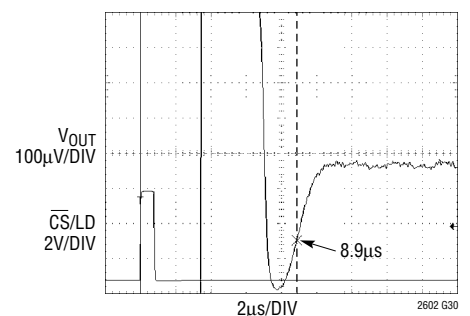

2602 G30

$V_{CC} = 5V$, $V_{REF} = 4.096V$
1/4-SCALE TO 3/4-SCALE STEP
 $R_L = 2k$, $C_L = 200pF$
AVERAGE OF 2048 EVENTS

TYPICAL PERFORMANCE CHARACTERISTICS

(LTC2622)

Integral Nonlinearity (INL)

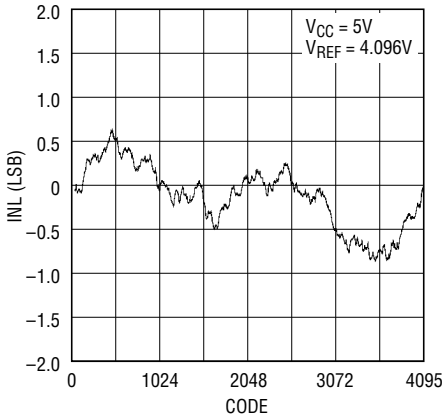

2602 G31

Differential Nonlinearity (DNL)

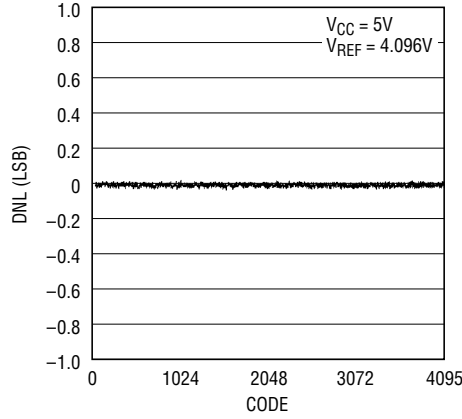

2602 G32

Settling to $\pm 1LSB$

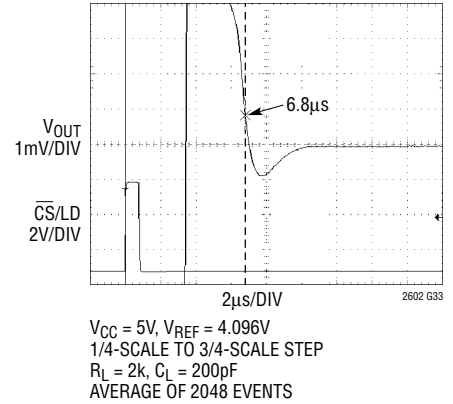

2602 G33

(LTC2602/LTC2612/LTC2622)

Current Limiting

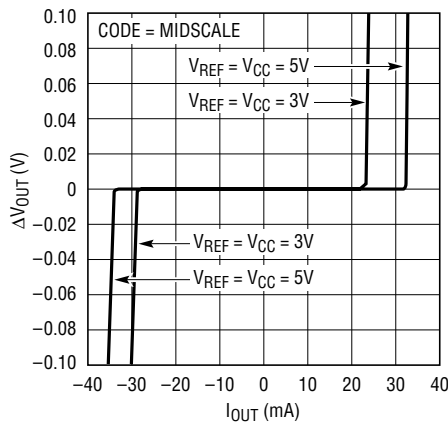

2602 G01

Load Regulation

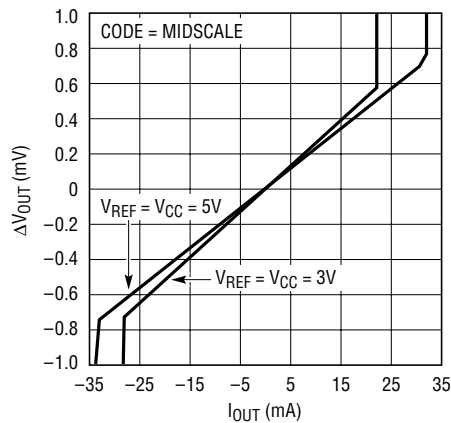

2602 G02

Offset Error vs Temperature

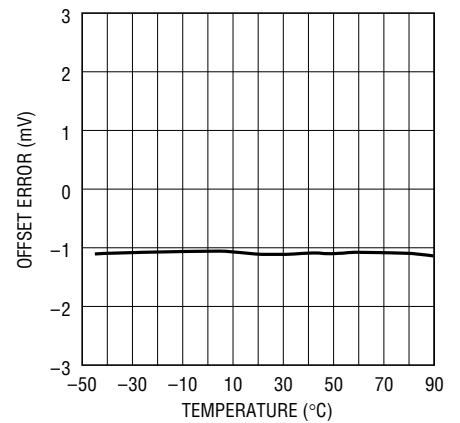

2602 G03

Zero-Scale Error vs Temperature

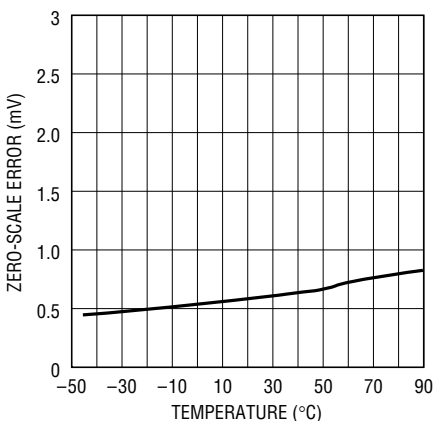

2602 G04

Gain Error vs Temperature

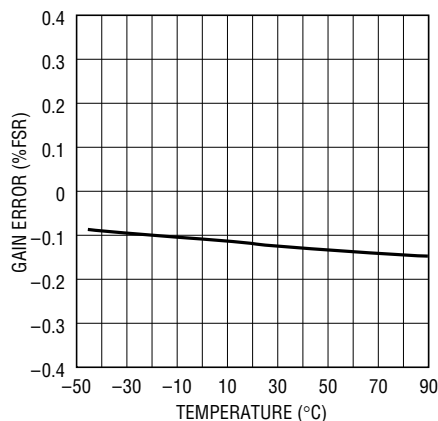

2602 G05

Offset Error vs VCC

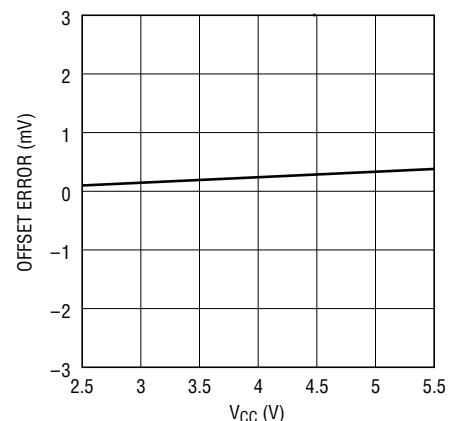

2602 G06

2602fa

TYPICAL PERFORMANCE CHARACTERISTICS

(LTC2602/LTC2612/LTC2622)

Gain Error vs V_{CC}

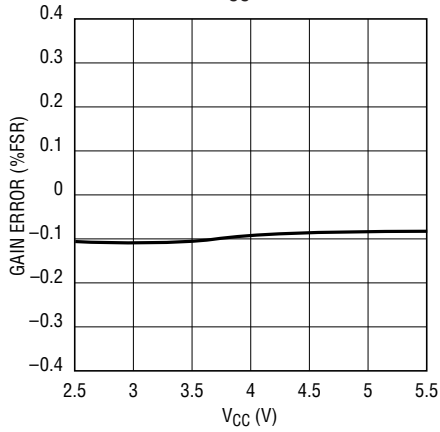

I_{CC} Shutdown vs V_{CC}

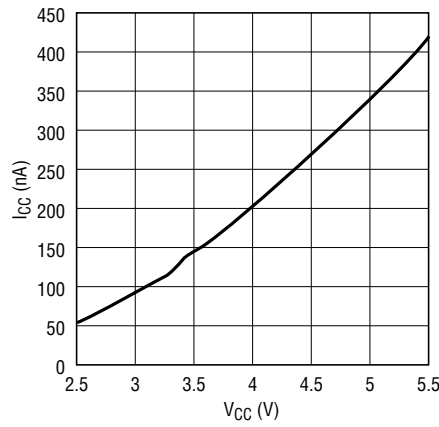

Large-Signal Settling

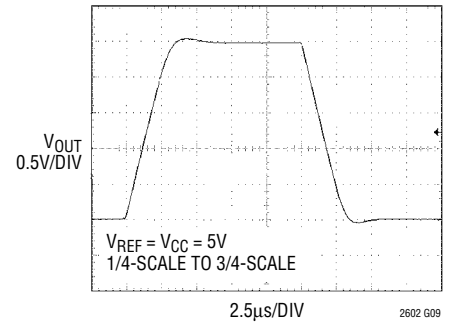

Midscale Glitch Impulse

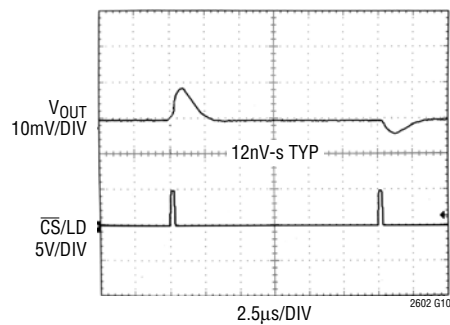

Power-On Reset Glitch

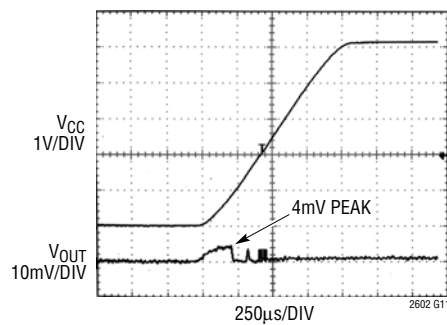

Headroom at Rails vs Output Current

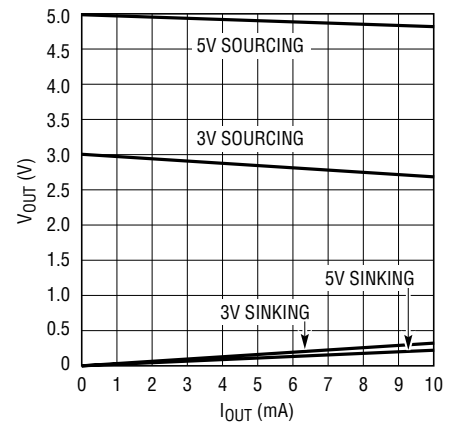

Supply Current vs Logic Voltage

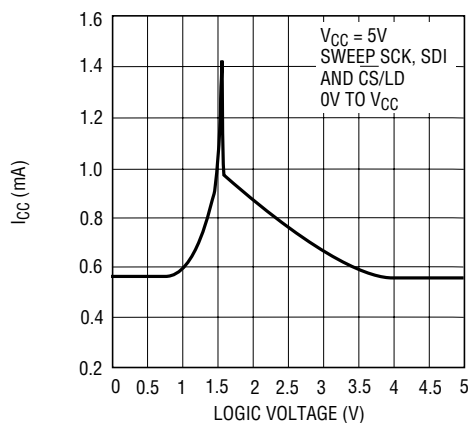

Exiting Power-Down to Midscale

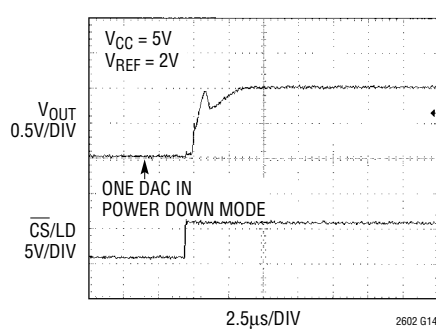

Multiplying Frequency Response

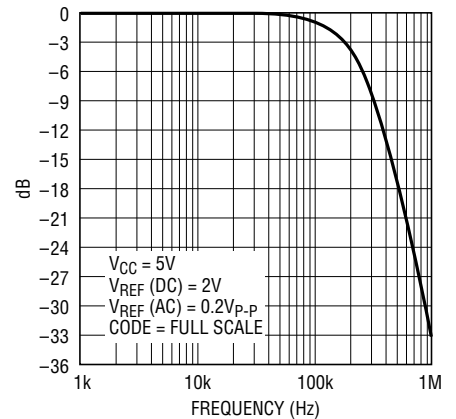

TYPICAL PERFORMANCE CHARACTERISTICS

(LTC2602/LTC2612/LTC2622)

**Output Voltage Noise,
0.1Hz to 10Hz**

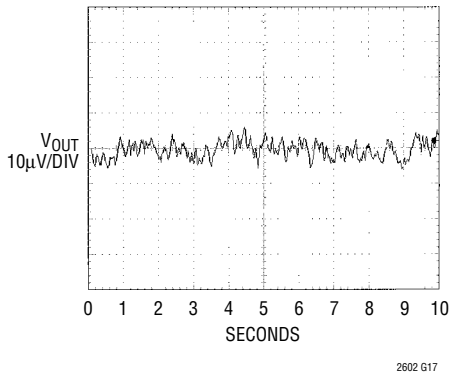

**Short-Circuit Output Current vs
V_{OUT} (Sinking)**

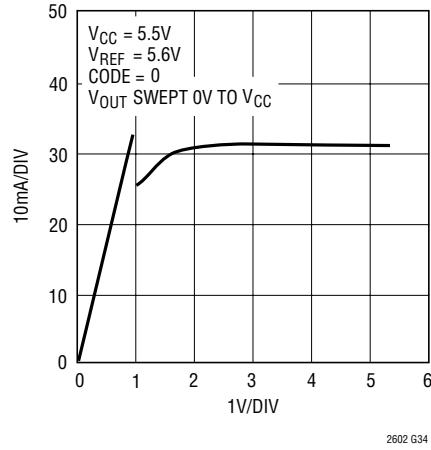

**Short-Circuit Output Current vs
V_{OUT} (Sourcing)**

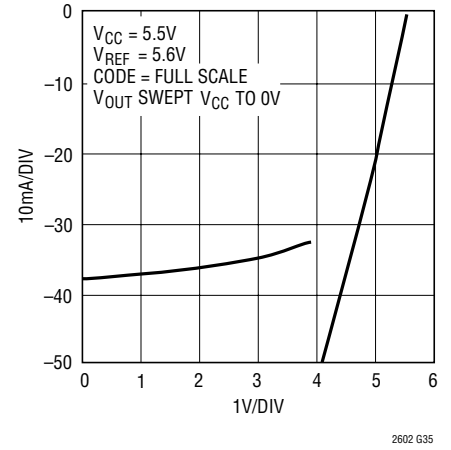

PIN FUNCTIONS

$\overline{CS/LD}$ (Pin 1): Serial Interface Chip Select/Load Input. When $\overline{CS/LD}$ is low, SCK is enabled for shifting data on SDI into the register. When $\overline{CS/LD}$ is taken high, SCK is disabled and the specified command (see Table 1) is executed.

SCK (Pin 2): Serial Interface Clock Input. CMOS and TTL compatible.

SDI (Pin 3): Serial Interface Data Input. Data is applied to SDI for transfer to the device at the rising edge of SCK. The

LTC2602/LTC2612/LTC2622 accept input word lengths of either 24 or 32 bits.

REF (Pin 4): Reference Voltage Input. $0V \leq V_{REF} \leq V_{CC}$.

$V_{OUT B}$ and $V_{OUT A}$ (Pins 5 and 8): DAC Analog Voltage Outputs. The output range is $0 - V_{REF}$.

V_{CC} (Pin 6): Supply Voltage Input. $2.5V \leq V_{CC} \leq 5.5V$.

GND (Pin 7): Analog Ground.

BLOCK DIAGRAM

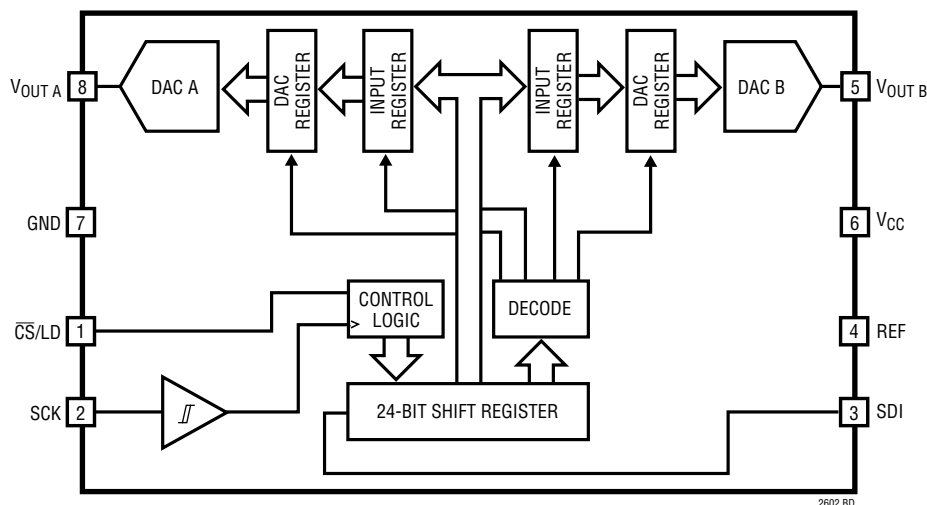

TIMING DIAGRAM

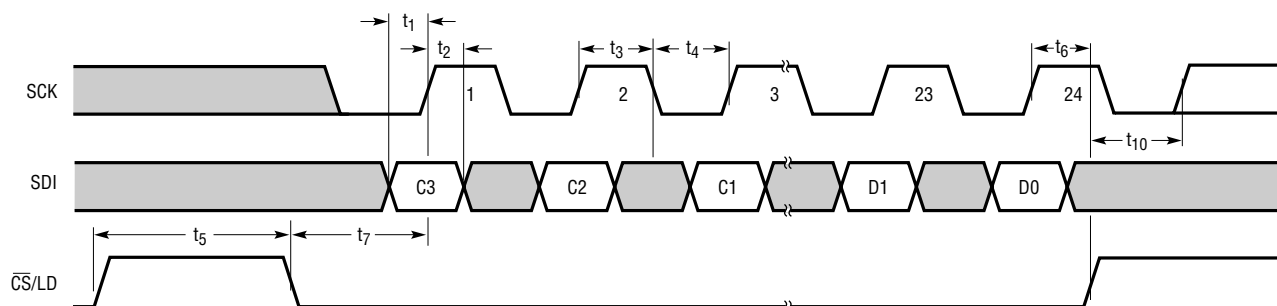

Figure 1

2602 F01

OPERATION

Power-On Reset

The LTC2602/LTC2612/LTC2622 clear the outputs to zero scale when power is first applied, making system initialization consistent and repeatable.

For some applications, downstream circuits are active during DAC power-up, and may be sensitive to nonzero outputs from the DAC during this time. The LTC2602/LTC2612/LTC2622 contain circuitry to reduce the power-on glitch; furthermore, the glitch amplitude can be made smaller by reducing the ramp rate of the power supply. For example, if the power supply is ramped to 5V in 1ms, the analog outputs rise less than 10mV above ground (typ) during power-on. See Power-On Reset Glitch in the Typical Performance Characteristics section.

Power Supply Sequencing

The voltage at REF (Pin 4) should be kept within the range $-0.3V \leq V_{REF} \leq V_{CC} + 0.3V$ (see Absolute Maximum Ratings). Particular care should be taken to observe these limits during power supply turn-on and turn-off sequences, when the voltage at V_{CC} (Pin 6) is in transition.

Transfer Function

The digital-to-analog transfer function is

$$V_{OUT(IDEAL)} = \left(\frac{k}{2^N} \right) V_{REF}$$

where k is the decimal equivalent of the binary DAC input code, N is the resolution and V_{REF} is the voltage at REF (Pin 4).

Table 1.

COMMAND*				
C3	C2	C1	C0	
0	0	0	0	Write to Input Register n
0	0	0	1	Update (Power Up) DAC Register n
0	0	1	0	Write to Input Register n, Update (Power Up) All n
0	0	1	1	Write to and Update (Power Up) n
0	1	0	0	Power Down n
1	1	1	1	No Operation
ADDRESS (n)*				
A3	A2	A1	A0	
0	0	0	0	DAC A
0	0	0	1	DAC B
1	1	1	1	All DACs

* Command and address codes not shown are reserved and should not be used.

Serial Interface

The \overline{CS}/LD input is level triggered. When this input is taken low, it acts as a chip-select signal, activating the SDI and SCK buffers and enabling the input shift register. Data (SDI input) is transferred at the next 24 rising SCK edges. The 4-bit command, C3-C0, is loaded first; then the 4-bit DAC address, A3-A0; and finally the 16-bit data word. The data word comprises the 16-, 14- or 12-bit input code, ordered MSB-to-LSB, followed by 0, 2 or 4 don't-care bits (LTC2602, LTC2612 and LTC2622 respectively). Data can only be transferred to the device when the \overline{CS}/LD signal is low. The rising edge of \overline{CS}/LD ends the data transfer and causes the device to carry out the action specified in the 24-bit input word. The complete sequence is shown in Figure 2a.

The command (C3-C0) and address (A3-A0) assignments are shown in Table 1. The first four commands in the table consist of write and update operations. A write operation loads a 16-bit data word from the 32-bit shift register into the input register of the selected DAC, n. An update operation copies the data word from the input register to the DAC register. Once copied into the DAC register, the data word becomes the active 16-, 14- or 12-bit input code, and is converted to an analog voltage at the DAC output. The update operation also powers up the selected DAC if it had been in power-down mode. The data path and registers are shown in the block diagram.

While the minimum input word is 24 bits, it may optionally be extended to 32 bits to accommodate microprocessors which have a minimum word width of 16 bits (2 bytes). To use the 32-bit word width, 8 don't-care bits are transferred to the device first, followed by the 24-bit word as just described. Figure 2b shows the 32-bit sequence.

Power-Down Mode

For power-constrained applications, power-down mode can be used to reduce the supply current whenever less than two outputs are needed. When in power-down, the buffer amplifiers, bias circuits and reference inputs are disabled, and draw essentially zero current. The DAC outputs are put into a high-impedance state, and the

OPERATION

INPUT WORD (LTC2602)

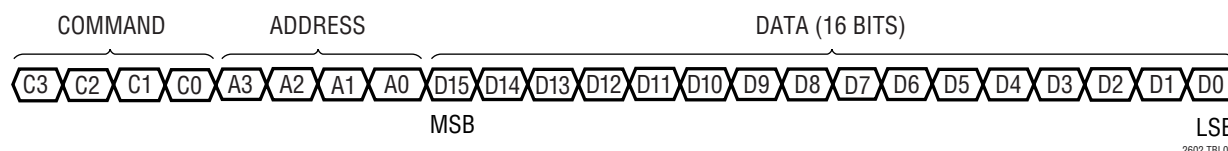

INPUT WORD (LTC2612)

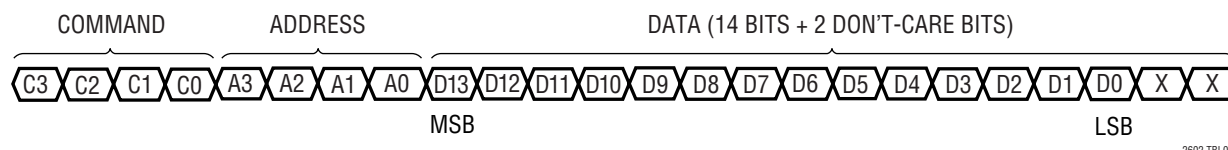

INPUT WORD (LTC2622)

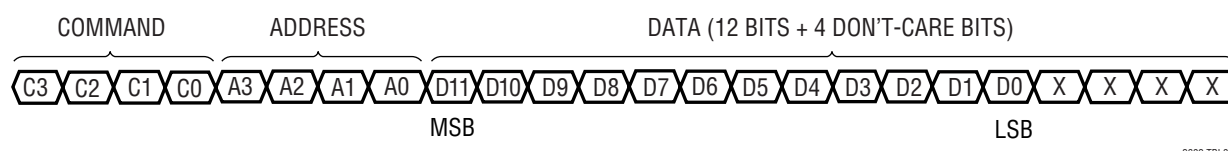

output pins are passively pulled to ground through individual 90k Ω resistors. Input- and DAC-register contents are not disturbed during power-down.

Either channel or both channels can be put into power-down mode by using command 0100_b in combination with the appropriate DAC address, (n). The 16-bit data word is ignored. The supply and reference currents are reduced by approximately 50% for each DAC powered down; the effective resistance at REF (pin 4) rises accordingly, becoming a high-impedance input (typically > 1G Ω) when both DACs are powered down.

Normal operation can be resumed by executing any command which includes a DAC update, as shown in Table 1. The selected DAC is powered up as its voltage output is updated. When a DAC which is in a powered-down state is powered up and updated, normal settling is delayed. If one of the two DACs is in a powered-down state prior to the update command, the power-up delay is 5 μ s. If, on the other hand, both DACs are powered down, then the main bias generation circuit block has been automatically shut down in addition to the individual DAC amplifiers and reference inputs. In this case, the power up delay time is 12 μ s (for V_{CC} = 5V) or 30 μ s (for V_{CC} = 3V).

Voltage Outputs

Each of the two rail-to-rail amplifiers contained in these parts has guaranteed load regulation when sourcing or sinking up to 15mA at 5V (7.5mA at 3V).

Load regulation is a measure of the amplifier's ability to maintain the rated voltage accuracy over a wide range of load conditions. The measured change in output voltage per milliampere of forced load current change is expressed in LSB/mA.

DC output impedance is equivalent to load regulation, and may be derived from it by simply calculating a change in units from LSB/mA to Ohms. The amplifiers' DC output impedance is 0.050 Ω when driving a load well away from the rails.

When drawing a load current from either rail, the output voltage headroom with respect to that rail is limited by the 25 Ω typical channel resistance of the output devices; e.g., when sinking 1mA, the minimum output voltage = 25 Ω • 1mA = 25mV. See the graph Headroom at Rails vs Output Current in the Typical Performance Characteristics section.

The amplifiers are stable driving capacitive loads of up to 1000pF.

OPERATION

Board Layout

The excellent load regulation and DC crosstalk performance of these devices is achieved in part by keeping “signal” and “power” grounds separated internally and by reducing shared internal resistance.

The GND pin functions both as the node to which the reference and output voltages are referred and as a return path for power currents in the device. Because of this, careful thought should be given to the grounding scheme and board layout in order to ensure rated performance.

The PC board should have separate areas for the analog and digital sections of the circuit. This keeps digital signals away from sensitive analog signals and facilitates the use of separate digital and analog ground planes which have minimal capacitive and resistive interaction with each other.

Digital and analog ground planes should be joined at only one point, establishing a system star ground as close to the device’s ground pin as possible. Ideally, the analog ground plane should be located on the component side of the board, and should be allowed to run under the part to shield it from noise. Analog ground should be a continuous and uninterrupted plane, except for necessary lead pads and vias, with signal traces on another layer.

The GND pin of the part should be connected to analog ground. Resistance from the GND pin to system star ground should be as low as possible. Resistance here will add directly to the effective DC output impedance of the device (typically 0.050Ω), and will degrade DC crosstalk. Note that the LTC2602/LTC2612/LTC2622 are no more susceptible to these effects than other parts of their type; on the contrary, they allow layout-based performance improvements to shine rather than limiting attainable performance with excessive internal resistance.

Rail-to-Rail Output Considerations

In any rail-to-rail voltage output device, the output is limited to voltages within the supply range.

Since the analog outputs of the device cannot go below ground, they may limit for the lowest codes as shown in Figure 3b. Similarly, limiting can occur near full scale when the REF pin is tied to V_{CC} . If $V_{REF} = V_{CC}$ and the DAC full-scale error (FSE) is positive, the output for the highest codes limits at V_{CC} as shown in Figure 3c. No full-scale limiting can occur if V_{REF} is less than $V_{CC} - FSE$.

Offset and linearity are defined and tested over the region of the DAC transfer function where no output limiting can occur.

OPERATION

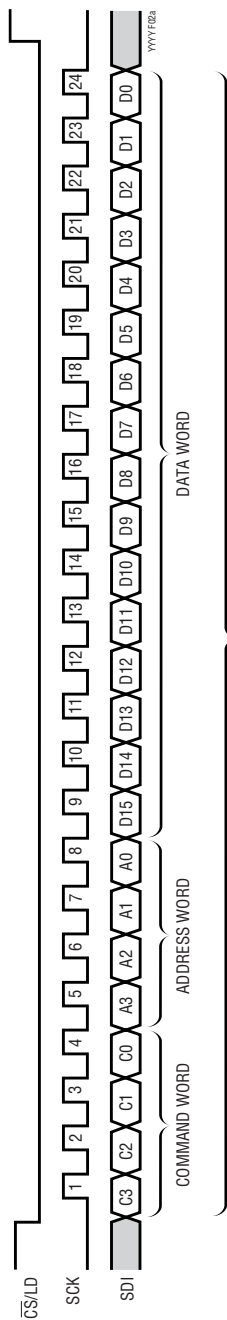

Figure 2a. LTC2602 24-Bit Load Sequence (Minimum Input Word)
 LTC2612 SDI Data Word 14-Bit Input Code + 2 Don't Care Bits
 LTC2622 SDI Data Word 12-Bit Input Code + 4 Don't Care Bits

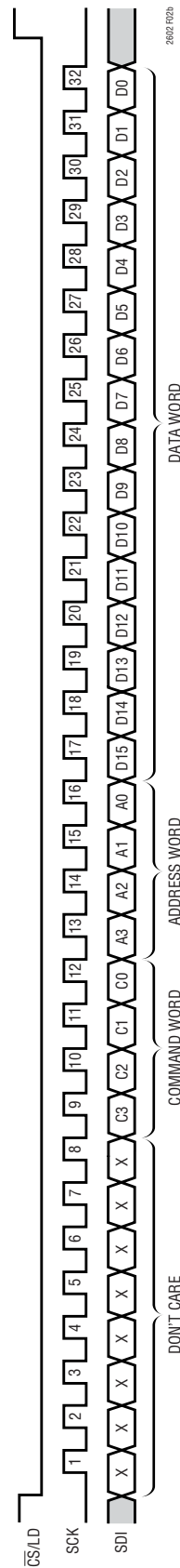
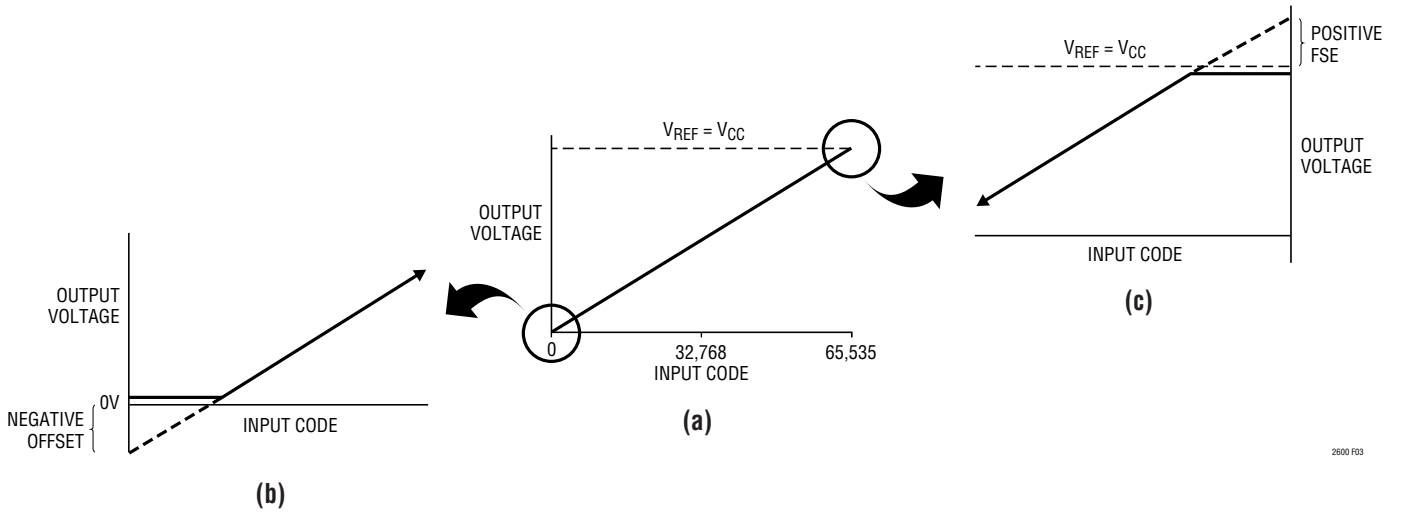

Figure 2b. LTC2602 32-Bit Load Sequence
 LTC2612 SDI Data Word 14-Bit Input Code + 2 Don't Care Bits
 LTC2622 SDI Data Word 12-Bit Input Code + 4 Don't Care Bits

OPERATION



2600 F03

Figure 3. Effects of Rail-to-Rail Operation On a DAC Transfer Curve. (a) Overall Transfer Function (b) Effect of Negative Offset for Codes Near Zero Scale (c) Effect of Positive Full-Scale Error for Codes Near Full Scale

PACKAGE DESCRIPTION

MS8 Package
8-Lead Plastic MSOP
 (Reference LTC DWG # 05-08-1660)

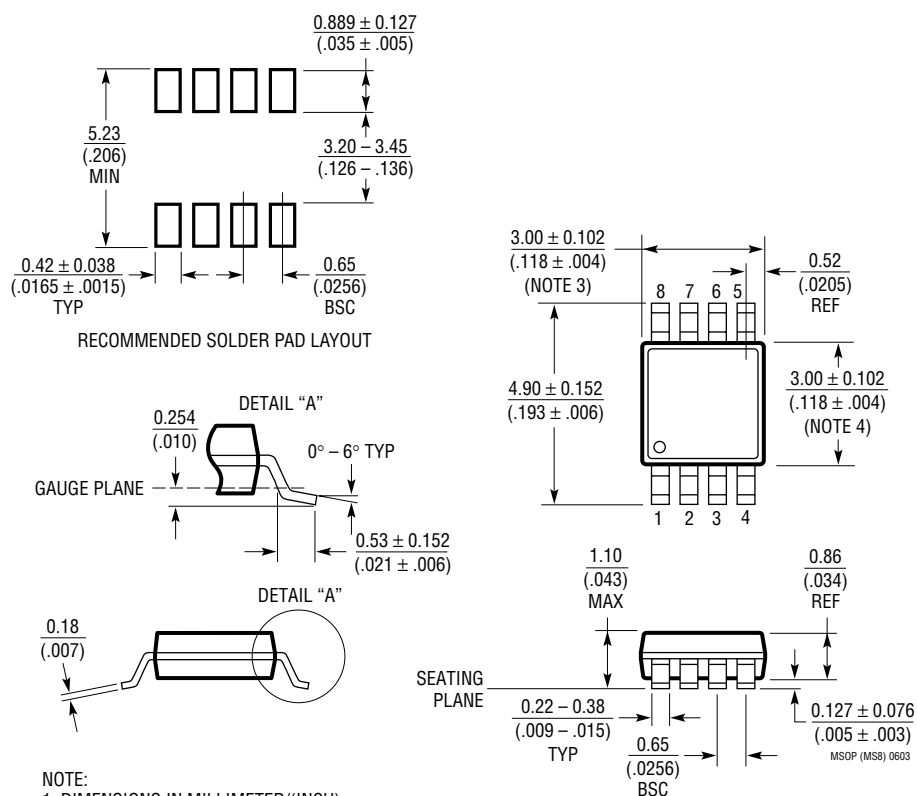

- NOTE:
1. DIMENSIONS IN MILLIMETER/(INCH)
 2. DRAWING NOT TO SCALE
 3. DIMENSION DOES NOT INCLUDE MOLD FLASH, PROTRUSIONS OR GATE BURRS.
MOLD FLASH, PROTRUSIONS OR GATE BURRS SHALL NOT EXCEED 0.152mm (.006") PER SIDE
 4. DIMENSION DOES NOT INCLUDE INTERLEAD FLASH OR PROTRUSIONS.
INTERLEAD FLASH OR PROTRUSIONS SHALL NOT EXCEED 0.152mm (.006") PER SIDE
 5. LEAD COPLANARITY (BOTTOM OF LEADS AFTER FORMING) SHALL BE 0.102mm (.004") MAX

RELATED PARTS

PART NUMBER	DESCRIPTION	COMMENTS
LTC1458/LTC1458L	Quad 12-Bit Rail-to-Rail Output DACs with Added Functionality	LTC1458: $V_{CC} = 4.5V$ to $5.5V$, $V_{OUT} = 0V$ to $4.096V$ LTC1458L: $V_{CC} = 2.7V$ to $5.5V$, $V_{OUT} = 0V$ to $2.5V$
LTC1654	Dual 14-Bit Rail-to-Rail V_{OUT} DAC	Programmable Speed/Power, $3.5\mu s/750\mu A$, $8\mu s/450\mu A$
LTC1655/LTC1655L	Single 16-Bit V_{OUT} DAC with Serial Interface in SO-8	$V_{CC} = 5V(3V)$, Low Power, Deglitched
LTC1657/LTC1657L	Parallel 5V/3V 16-Bit V_{OUT} DAC	Low Power, Deglitched, Rail-to-Rail V_{OUT}
LTC1660/LTC1665	Octal 10/8-Bit V_{OUT} DAC in 16-Pin Narrow SSOP	$V_{CC} = 2.7V$ to $5.5V$, Micropower, Rail-to-Rail Output
LTC1661	Dual 10-Bit V_{OUT} DAC in 8-Lead MSOP Package	$V_{CC} = 2.7V$ to $5.5V$, $60\mu A$ per DAC, Rail-to-Rail Output
LTC1821	Parallel 16-Bit Voltage Output DAC	Precision 16-Bit Settling in $2\mu s$ for 10V Step
LTC2600/LTC2610/ LTC2620	Octal 16/14/12-Bit Rail-to-Rail DACs in 16-Lead SSOP	$250\mu A$ per DAC, $2.5V$ to $5.5V$ Supply Range Rail-to-Rail Output