

FEATURES

- Extremely Low $R_{DS(ON)}$ Switch: 0.07Ω
- No Parasitic Body Diode
- Built-In Short-Circuit Protection: 2A
- Built-In Thermal Overload Protection
- Operates from 2.7V to 5.5V
- Inrush Current Limited
- Ultralow Standby Current: $0.01\mu A$
- Built-In Charge Pump
- Controlled Rise and Fall Times: $t_R = 1ms$
- Single Switch in 8-Pin SO Package
- Dual Switch in Narrow 16-Pin SO Package

APPLICATIONS

- Notebook Computer Power Management
- Power Supply/Load Protection
- Supply/Battery Switch-Over Circuits
- Circuit Breaker Function
- "Hot Swap" Board Protection
- Peripheral Power Protection

DESCRIPTION

The LTC[®]1477/LTC1478 protected high side switches provide extremely low $R_{DS(ON)}$ switching with built-in protection against short-circuit and thermal overload conditions. A built-in charge pump generates gate drive higher than the supply voltage to fully enhance the internal NMOS switch. This switch has no parasitic body diode and therefore no current flows through the switch when it is turned off and the output is forced above the input supply voltage. (DMOS switches have parasitic body diodes that become forward biased under these conditions.)

Two levels of protection are provided by the LTC1477/LTC1478. The first level of protection is short-circuit current limit which is set at 2A. The short-circuit current can be reduced to as low as 0.85A by disconnecting portions of the power device (see Applications Information). The second level of protection is provided by thermal overload protection which limits the die temperature to approximately 130°C.

The LTC1477 single is available in 8-lead SO packaging. The LTC1478 dual is available in 16-lead SO packaging.

 LTC and LT are registered trademarks of Linear Technology Corporation.

SIMPLIFIED BLOCK DIAGRAM

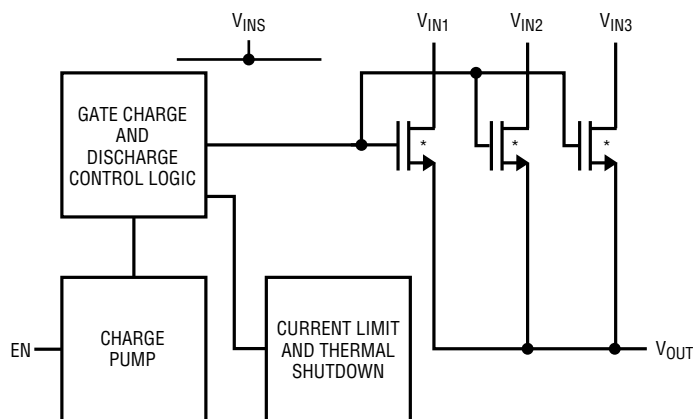

*NMOS SWITCHES WITH NO PARASITIC BODY DIODES

LTC1477/1478 • TA01

Switch Output Voltage

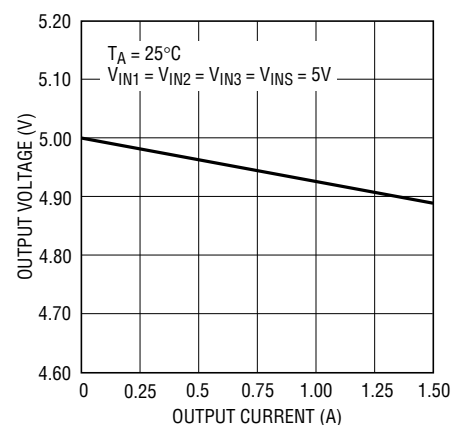

LTC1477/1478 • TP02

ABSOLUTE MAXIMUM RATINGS

Supply Voltage 7V
 Enable Input Voltage (7V) to (GND – 0.3V)
 Output Voltage (OFF) (Note 1) (7V) to (GND – 0.3V)
 Output Short-Circuit Duration Indefinite
 Junction Temperature 110°C

Operating Temperature
 LTC1477C/LTC1478C 0°C to 70°C
 Storage Temperature Range –65°C to 150°C
 Lead Temperature (Soldering, 10 sec) 300°C

PACKAGE/ORDER INFORMATION

<p>S8 PACKAGE 8-LEAD PLASTIC SO $T_{JMAX} = 110^{\circ}\text{C}$, $\theta_{JA} = 120^{\circ}\text{C/W}$</p>	ORDER PART NUMBER	<p>S PACKAGE 16-LEAD PLASTIC SO $T_{JMAX} = 110^{\circ}\text{C}$, $\theta_{JA} = 100^{\circ}\text{C/W}$</p>	ORDER PART NUMBER
	LTC1477CS8		LTC1478CS
	S8 PART MARKING		
	1477		

Consult factory for Industrial and Military grade parts.

ELECTRICAL CHARACTERISTICS

$V_{INS} = V_{IN1} = V_{IN2} = V_{IN3} = 5\text{V}$ (Note 2), $T_A = 25^{\circ}\text{C}$, unless otherwise noted. Each channel of the LTC1478 is tested separately (Note 3).

SYMBOL	PARAMETER	CONDITIONS	MIN	TYP	MAX	UNITS	
V_{IN}	Supply Voltage Range		2.7		5.5	V	
I_{VIN}	Supply Current	Switch OFF, Enable = 0V Switch ON, Enable = 5V, $V_{IN} = 5\text{V}$ Switch ON, Enable = 3.3V, $V_{IN} = 3.3\text{V}$	●	0.01 120 80	10 180 120	μA μA μA	
R_{ON}	ON Resistance	$V_{INS} = V_{IN1} = V_{IN2} = V_{IN3} = 5\text{V}$, $I_{OUT} = 1\text{A}$ $V_{INS} = V_{IN1} = V_{IN2} = V_{IN3} = 3.3\text{V}$, $I_{OUT} = 1\text{A}$ $V_{INS} = V_{IN1} = 5\text{V}$, $V_{IN2} = V_{IN3} = \text{NC}$, $I_{OUT} = 0.5\text{A}$ $V_{INS} = V_{IN1} = 3.3\text{V}$, $V_{IN2} = V_{IN3} = \text{NC}$, $I_{OUT} = 0.5\text{A}$		0.07 0.08 0.12 0.13	0.12 0.12 0.20 0.20	Ω Ω Ω Ω	
I_{LKG}	Output Leakage Current OFF	Switch OFF, Enable = 0V	●		± 20	μA	
I_{SC}	Short-Circuit Current Limit	$V_{INS} = V_{IN1} = V_{IN2} = V_{IN3} = 5\text{V}$, $V_{OUT} = 0\text{V}$, (Note 4) $V_{INS} = V_{IN1} = 5\text{V}$, $V_{IN2} = V_{IN3} = \text{NC}$, $V_{OUT} = 0\text{V}$, (Note 4)		1.60 0.68	2.00 0.85	2.40 1.02	A A
V_{ENH}	Enable Input High Voltage	$3.0\text{V} \leq V_{INS} \leq 5.5\text{V}$	●	2.0		V	
V_{ENL}	Enable Input Low Voltage	$3.0\text{V} \leq V_{INS} \leq 5.5\text{V}$	●		0.8	V	
I_{EN}	Enable Input Current	$0\text{V} \leq V_{EN} \leq 5.5\text{V}$	●		± 1	μA	
t_{D+R}	Delay and Rise Time	$R_{OUT} = 100\Omega$, $C_{OUT} = 1\mu\text{F}$, to 90% of Final Value		0.50	1.00	2.00	ms

The ● denotes specifications which apply over the full operating temperature range.

Note 1: The V_{OUT} pins must be connected together.

Note 2: The V_{INS} and V_{IN1} pins must be connected together. The V_{IN2} and V_{IN3} pins are typically connected to V_{INS} and V_{IN1} pins but can be selectively disconnected to reduce the short-circuit current limit and

increase the ON resistance of the switch. The LTC1478 GND pins must be connected together. (See Pin Functions and Block Diagram for more detail.)

Note 3: Other channel turned OFF, i.e. AEN and BEN = 0V.

Note 4: The output is protected with fold-back current limit which reduces the short-circuit (0V) currents below peak permissible current levels at higher output voltages. (See Typical Performance Characteristics for further detail on output current versus output voltage).

TYPICAL PERFORMANCE CHARACTERISTICS

Supply Current (ON)

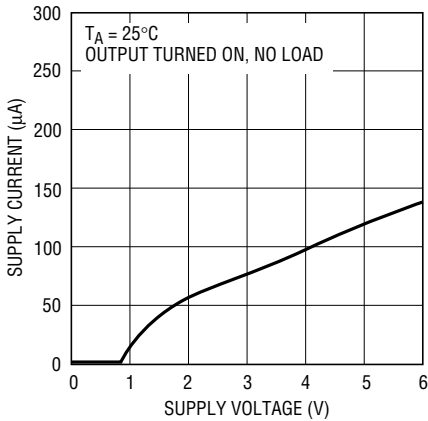

LTC1477/1478 • TPC01

Switch Resistance

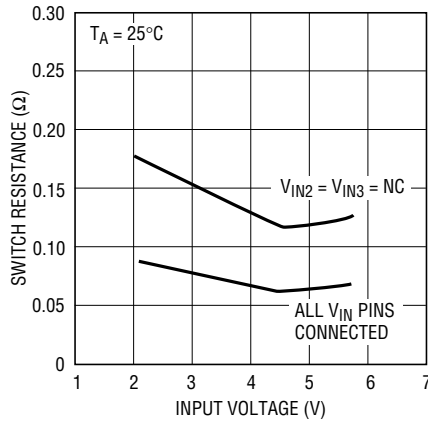

LTC1477/1478 • TPC02

Switch Resistance (5V)

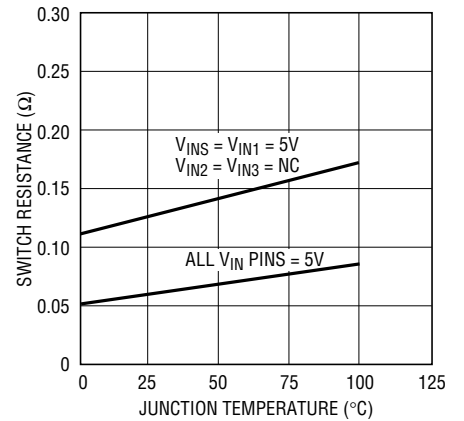

LTC1477/1478 • TPC03

Switch Resistance (3.3V)

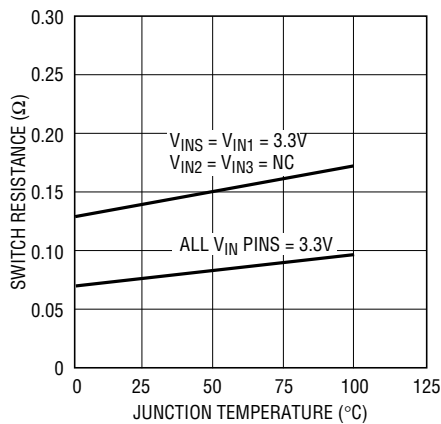

LTC1477/1478 • TPC04

Short-Circuit Current

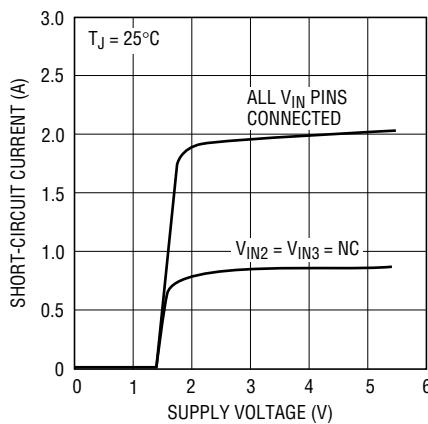

LTC1477/1478 • TPC05

Output Current (5V)

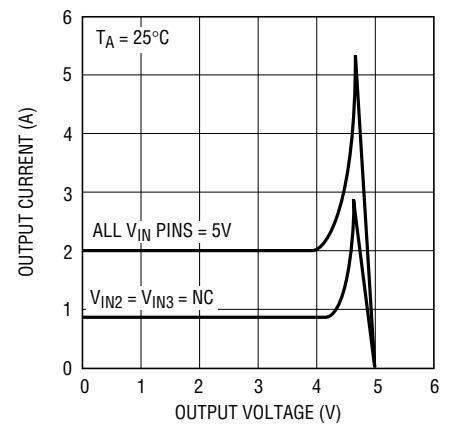

LTC1477/1478 • TPC06

Output Current (3.3V)

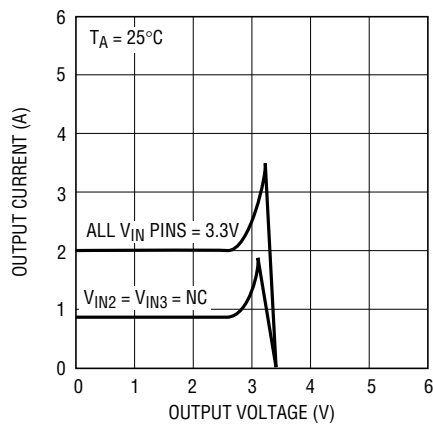

LTC1477/1478 • TPC07

Inrush Current (5V)

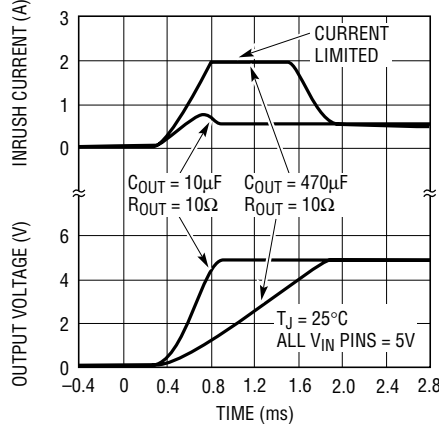

LTC1477/1478 • TPC08

Inrush Current (3.3V)

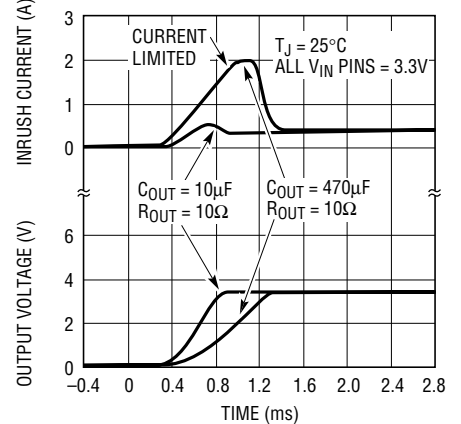

LTC1477/1478 • TPC09

PIN FUNCTIONS

LTC1477

EN (Pin 4): The enable input is a high impedance CMOS gate with an ESD protection diode to ground and should not be forced below ground. This input has about 100mV of built-in hysteresis to ensure clean switching.

V_{INS} , V_{IN1} (Pins 3,2): The V_{INS} supply pin must always be connected to the V_{IN1} supply pin (see Block Diagram). The V_{INS} supply pin provides power for the input control logic, the current limit and thermal shutdown circuitry; plus provides a sense connection to the input power supply. The gate of the NMOS switch is powered by a charge pump from the V_{INS} supply pin (see Block Diagram). The V_{IN1} supply pin provides connection to the drain of 1/2 of the output power device.

V_{IN2} , V_{IN3} (Pins 7,6): The V_{IN2} and V_{IN3} supply pins are typically tied to the V_{INS} and V_{IN1} supply pins for lowest ON resistance; i.e., when all four V_{IN} pins are connected together the entire power device is connected (see Block Diagram). Each auxiliary supply pin, V_{IN2} and V_{IN3} , is connected to the drain of 1/4 of the power device. The V_{IN2} and V_{IN3} pins can be selectively disconnected to reduce the short-circuit current limit at the expense of higher $R_{DS(ON)}$. (See Applications Information section for more details.)

V_{OUT} (Pins 1,8): The output pins of the LTC1477 must always be tied together. The output is protected against accidental short circuits to ground by a current limit circuit which protects the system power supply and load against damage. A second level of protection is provided by thermal shutdown circuitry which limits the die temperature to 130°C.

LTC1478

AEN, BEN (Pins 4,12): The enable inputs are high impedance CMOS gates with ESD protection diodes to ground and should not be forced below ground. These inputs have about 100mV of built-in hysteresis to ensure clean switching.

AV_{INS} , AV_{IN1} , BV_{INS} , BV_{IN1} (Pins 3,2; 11,10): The AV_{INS} or BV_{INS} supply pin must always be connected to the AV_{IN1} or BV_{IN1} supply pin (see Block Diagram). The AV_{INS} and BV_{INS} supply pins provide power for the input control logic, the current limit and thermal shutdown circuitry; plus, provides a sense connection to the input power supply. The gate of the NMOS switch is powered by a charge pump from the AV_{INS} and BV_{INS} supply pins (see Block Diagram). The AV_{IN1} and BV_{IN1} supply pins provide connection to the drain of 1/2 of the output power device.

AV_{IN2} , AV_{IN3} , BV_{IN2} , BV_{IN3} , (Pins 15,14; 7,6): The AV_{IN2} , AV_{IN3} , BV_{IN2} and BV_{IN3} supply pins are typically tied to the AV_{INS} , AV_{IN1} , BV_{INS} and BV_{IN1} supply pins for lowest ON resistance; i.e., when all four AV_{IN} , BV_{IN} pins are connected together the entire power device is connected (see Block Diagram). Each auxiliary supply pin, AV_{IN2} , AV_{IN3} , BV_{IN2} and BV_{IN3} , is connected to the drain of approximately 1/4 of the corresponding power device. The AV_{IN2} , AV_{IN3} , BV_{IN2} and BV_{IN3} pins can be selectively disconnected to reduce the short-circuit current limit at the expense of higher $R_{DS(ON)}$. (See Applications Information section for more details.)

AV_{OUT} , BV_{OUT} (Pins 1,16; 8,9): The outputs of the LTC1478 are protected against accidental short circuits to ground by a current limit circuit which protects the system power supplies and loads against damage. A second level of protection is provided by thermal shutdown circuitry which limits the die temperature to approximately 130°C.

OPERATION (LTC1477 or single channel of LTC1478)

Input TTL-CMOS Converter

The LTC1477 enable input is designed to accommodate a wide range of 3V and 5V logic families. The input threshold voltage is approximately 1.4V with 100mV of hysteresis. The input enables the bias generator, the gate charge pump and the protection circuitry. Therefore, when the enable input is turned off, the entire circuit is powered down and the supply current drops below 1 μ A.

Ramped Switch Control

The LTC1477 gate charge pump includes circuitry which ramps the NMOS switch on slowly (1ms typical rise time) but turns it off much more quickly (typically 20 μ s).

Bias, Oscillator and Gate Charge Pump

When the switch is enabled, a bias current generator and high frequency oscillator are turned on. The on-chip capacitive charge pump generates approximately 12V of

gate drive for the internal low $R_{DS(ON)}$ NMOS switch from the power supply. No external 12V supply is required to switch the output.

Switch Protection

Two levels of protection are designed into the power switch in the LTC1477. The switch is protected against accidental short circuits with a current limit circuit which limits the output current to typically 2A when the output is shorted to ground. The LTC1477 also has thermal shutdown set at approximately 130°C which limits the power dissipation to safe levels.

LTC1478 Operation

The LTC1478 dual protected switch can be thought of as two independent LTC1477 single protected switches. The input supply voltages may be from separate power sources. The ground connection, however, is common to both channels and must be connected to the same potential.

BLOCK DIAGRAM (LTC1477 or single channel of LTC1478)

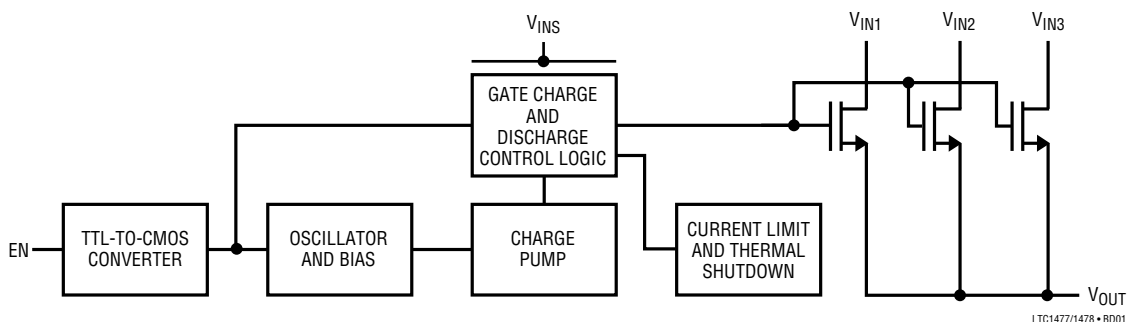

APPLICATIONS INFORMATION

Tailoring I_{LIMIT} and $R_{DS(ON)}$ for Load Requirements

The LTC1477 is designed to current limit at approximately 2A during a short circuit with all the V_{IN} pins connected to the input power supply. It is possible however, to reduce this current by selectively disconnecting two of the four power supply pins (V_{IN2} and V_{IN3}). Table 1 lists the effects of disconnecting these pins on $R_{DS(ON)}$ and short-circuit current limit

Table 1. Effects of Disconnecting V_{IN2} and V_{IN3}

	ALL V_{IN} PINS CONNECTED	V_{IN3} DISCONNECTED	V_{IN2} AND V_{IN3} DISCONNECTED
$R_{DS(ON)}$	0.07 Ω	0.09 Ω	0.12 Ω
I_{LIMIT}	2A	1.5A	0.85A

Note: 5V Operation

Note that there is an inverse relationship between output current limit and switch resistance. This allows the tailor-

APPLICATIONS INFORMATION

ing of the switch parameters to the expected load current and system current limit requirements.

A couple of examples are helpful:

1. If a nominal load of 1A was controlled by the switch configured to current limit at 2A (all V_{IN} pins connected together), the $R_{DS(ON)}$ would be 0.07Ω and the voltage drop across the switch would be 70mV. The power dissipated by the switch would only be 70mW.
2. If a nominal load of 0.5A was controlled by the switch configured to current limit at 0.85A (V_{IN2} and V_{IN3} disconnected), the $R_{DS(ON)}$ would increase to 0.14Ω . But the voltage drop would remain at 70mV and the switch power dissipation would drop to 35mW.

Supply Bypassing

For best results, bypass the supply input pins with a single $1.0\mu\text{F}$ capacitor as close as possible to the LTC1477. Sometimes, much larger capacitors are already available at the output of the power supply. In this case, it is still good practice to use a $0.1\mu\text{F}$ capacitor as close as possible

to the LTC1477, especially if the power supply output capacitor is more than 2 inches away on the printed circuit board.

Output Capacitor

The output pin is designed to ramp on slowly, typically 1ms rise time. Therefore, very large output capacitors can be driven without producing voltage spikes on the supply pins (see graphs in Typical Performance Characteristics). The output pin should have a $1\mu\text{F}$ capacitor for noise reduction and smoothing.

Supply and Input Sequencing

The LTC1477 is designed to operate with continuous power (quiescent current drops to $< 1\mu\text{A}$ when disabled). If the power must be turned off, for example to enter a system “sleep” mode, the enable input must be turned off $100\mu\text{s}$ before the input supply is turned off to ensure that the gate of the NMOS switch is completely discharged before power is removed. However, the input control and power can be applied simultaneously during power up.

TYPICAL APPLICATIONS

2A Protected Switch

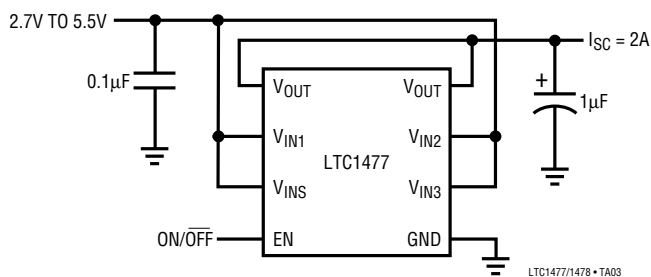

1.5A Protected Switch

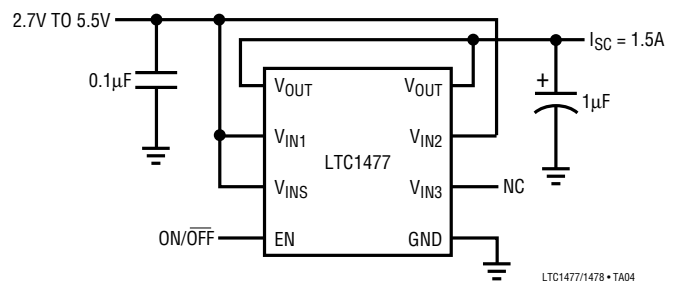

0.85A Protected Switch

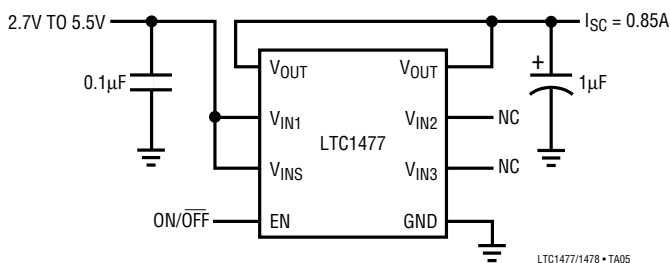

2A Protected Switch Driving a Large Capacitive Load

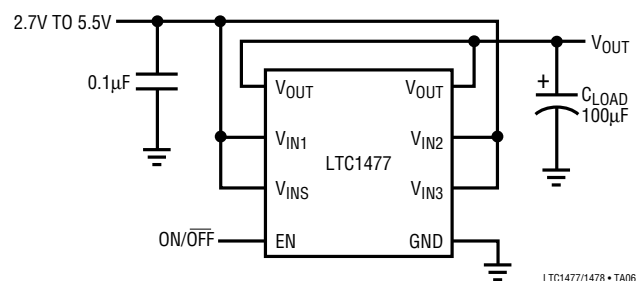

PACKAGE DESCRIPTION Dimension in inches (millimeters) unless otherwise noted.

S8 Package
8-Lead Plastic Small Outline (Narrow 0.150)
 (LTC DWG # 05-08-1610)

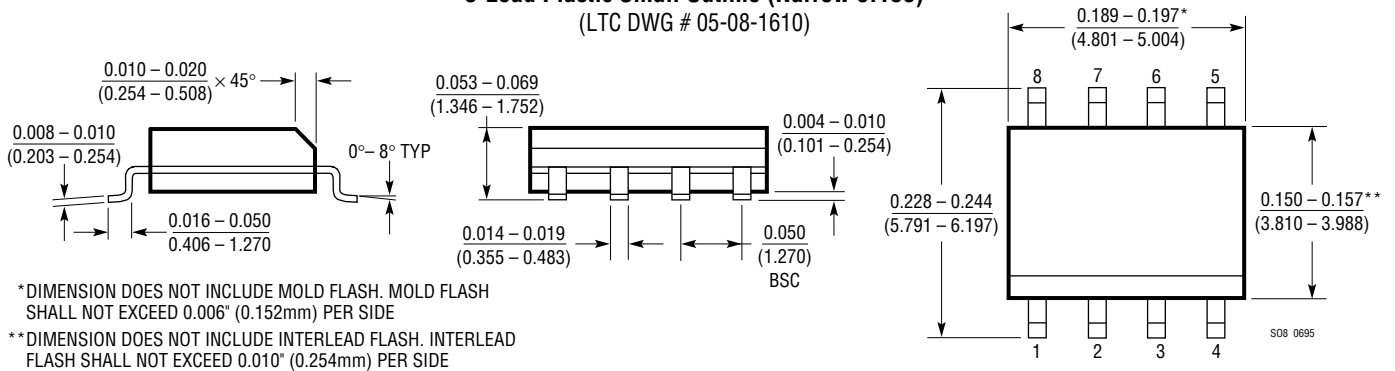

S Package
16-Lead Plastic Small Outline (Narrow 0.150)
 (LTC DWG # 05-08-1610)

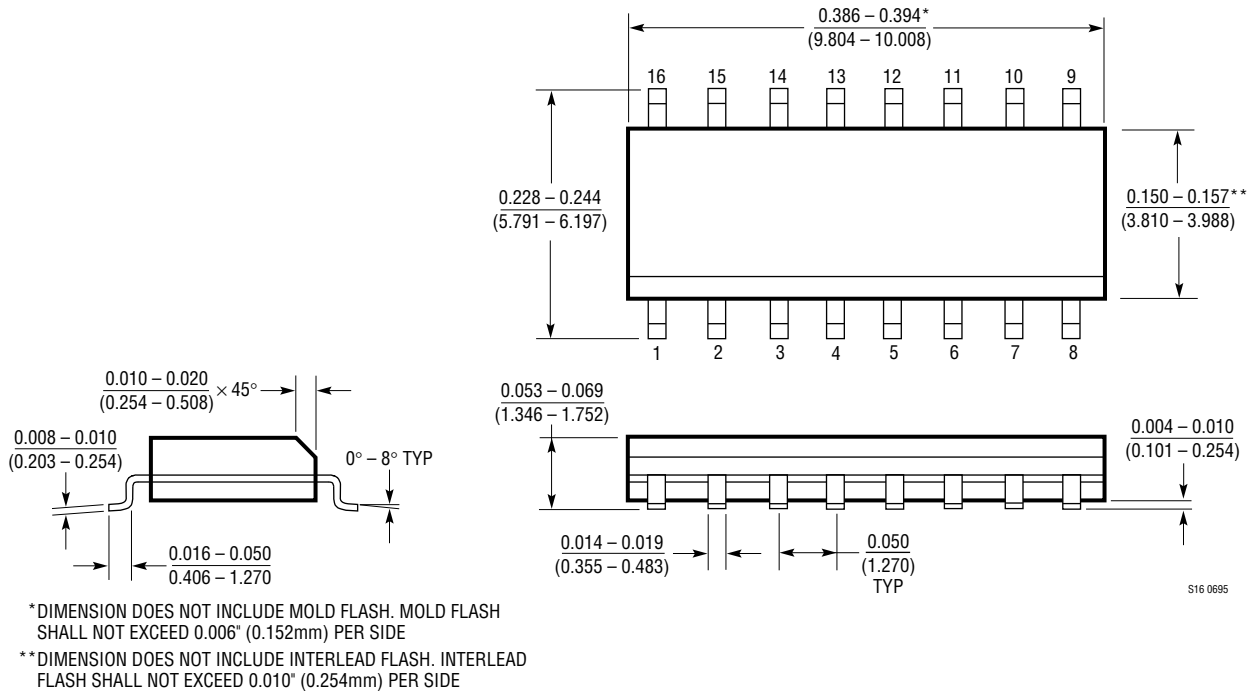

RELATED PARTS

PART NUMBER	DESCRIPTION	COMMENTS
LTC1153	Electronic Circuit Breaker	MOSFET Driver with Adjustable Reset Time
LTC1154	Single High Side Driver	MOSFET Driver with Switch Status Output
LTC1155	Dual High Side Driver	Dual MOSFET Driver with Protection
LTC1470	5V and 3.3V V _{CC} Switch	SafeSlot™ Protected Switch in 8-Lead SO
LTC1471	Dual 5V and 3.3V V _{CC} Switch	Dual Version of LTC1470 in 16-Lead SO
LTC1472	PCMCIA V _{CC} and VPP Switches	Complete Single Channel SafeSlot Protection

SafeSlot is a trademark of Linear Technology Corporation.